

# FlashPoints Help

# Table of Contents

|  |           |
|--|-----------|
| <b>1. Welcome to FlashPoints</b> .....                                     | <b>3</b>  |
| <b>2. The Screen Layout</b> .....  | <b>4</b>  |
| 2.1. The Menu .....  | 5         |
| 2.2. The Toolbar .....   | 6         |
| 2.3. The Tool Palette .....  | 7         |
| 2.4. The Canvas .....  | 8         |
| 2.5. The Status Bar .....  | 9         |
| <b>3. Starting a New Job</b> .....   | <b>11</b> |
| 3.1. The FlashPoints Design Process .....                                  | 12        |
| 3.2. Printing a Job .....  | 13        |
| 3.3. Saving a Job .....  | 14        |
| <b>4. Making a Drawing</b> .....   | <b>15</b> |
| 4.1. Starting with a Hood .....  | 16        |
| 4.2. Drawing Ducts .....   | 17        |
| 4.3. Adding Appliances .....   | 18        |
| 4.4. The Minibar .....   | 19        |
| 4.5. Keyboard Shortcuts .....  | 20        |
| 4.6. Automatic Placement .....   | 20        |
| 4.7. Selecting Items .....   | 21        |
| 4.8. Scaling the drawing .....   | 22        |
| 4.9. Reposition Drawing .....  | 23        |
| 4.10. Labels and other Job Settings .....                                  | 23        |
| 4.11. Moving Labels .....  | 24        |
| 4.12. Nozzle Height Labels .....   | 24        |
| 4.13. Add an Image .....   | 25        |
| 4.14. Text Notes .....   | 26        |
| 4.15. Using Room Guides .....  | 27        |
| 4.16. Protecting the Appliances .....                                      | 28        |
| 4.16.1. Specifying Adequate Protection .....                               | 29        |
| 4.16.2. Overriding Protection .....  | 29        |
| 4.17. Locking Appliances .....   | 30        |
| 4.18. Adding Other Objects .....   | 31        |
| 4.19. Using Guides .....   | 32        |
| <b>5. Entering Job Information</b> .....                                   | <b>33</b> |
| 5.1. Customer Information .....  | 33        |
| 5.2. Job Notes .....   | 33        |
| 5.3. Job Identification .....  | 34        |
| 5.4. Installation Company Information .....                                | 34        |
| <b>6. Piping the System</b> .....  | <b>36</b> |
| 6.1. Drawing Pipe .....  | 37        |
| 6.2. Using the Pipe Tool .....   | 38        |
| 6.3. Piping Tips .....   | 39        |
| 6.4. Pipe Calculator .....   | 40        |
| <b>7. Completing the System [Fire Equipment Dealer Version Only]</b> ..... | <b>41</b> |
| 7.1. Specifying Materials [Fire Equipment Dealer Version Only] .....       | 42        |
| 7.2. Costing the Job [Fire Equipment Dealer Version Only] .....            | 44        |
| 7.3. Submittal Pages .....   | 46        |
| <b>8. Printing Reports</b> .....   | <b>47</b> |
| 8.1. Enhanced Printing .....   | 48        |
| 8.1.1. Pipe Diagram .....  | 50        |
| 8.2. Printing a Submittal Package .....                                    | 52        |
| 8.3. Managing Credits .....  | 53        |
| 8.4. Printing a Completion Certificate .....                               | 54        |
| <b>9. Importing and Exporting</b> .....                                    | <b>55</b> |
| <b>10. Setting Preferences</b> .....                                       | <b>56</b> |

|                                     |           |
|-------------------------------------|-----------|
| 10.1. Sharing a Database .....      | 57        |
| 10.2. Adding a Company Logo.....    | 58        |
| <b>11. FlashPoints Survey .....</b> | <b>59</b> |
| 11.1. Setting Up a Survey User..... | 60        |
| 11.2. Importing a Survey .....      | 62        |
| 11.3. Managing Survey Users.....    | 63        |

# 1. Welcome to FlashPoints



Design, draw, and price fire suppression systems and fire scenes quickly with FlashPoints SuppressionCAD. As a fire suppression installation professional you spend countless hours planning, costing, and drawing each fire suppression system you bid on. FlashPoints SuppressionCAD reduces all of this effort to minutes!

This Help file is designed to guide you through using FlashPoints SuppressionCAD. Feel free to check Help often to learn a new feature, or just refresh your memory. But if you run into trouble, or need more assistance than this Help file has to offer, please visit our website at <http://www.flash-soft.com>

**NOTICE:** Please remember that FlashPoints is meant to be a tool to assist in the design of fire suppression systems. It is not meant to replace the knowledge and expertise of a trained fire suppression professional. Although FlashPoints will attempt to provide accurate results, the fire suppression system designer/installer is ultimately responsible for the final system design. Every effort has been made to make FlashPoints flexible and user-friendly. If information or documents, produced by FlashPoints are not correct, it is the designer's responsibility to correct any errors prior to system installation. Flash-Soft, Inc. shall not be liable for improper fire suppression system design and/or installation.

## 2. The Screen Layout

The screenshot displays the FlashPoints software interface for kitchen protection design. The interface is divided into several key areas:

- 1. Menu:** Located at the top, it includes a menu bar with options like File, Edit, View, Store, Help, and System. The current system is identified as 'AX100-KP Amerex Kitchen Protection'.
- 2. ToolPanel:** A vertical sidebar on the left containing various equipment icons such as HOOD, DUCT, RANGERS, BROILER, CHAR, NOZZLE, DETECT, CYLINDER, GAS VALVE, PULL BOX, and CONTROL. It also shows 'UNPROTECTED EQUIPMENT' and a 'Required Flow Value 18' with a fire extinguisher icon.
- 3. Canvas:** The main workspace showing a 3D perspective view of a kitchen layout. It includes a 'CONTROL PANEL' at the top, two '3.75 GAL' gas cylinders, and various kitchen equipment labeled 'CHARBROILER', 'RANGE', 'GRIDDLE', and 'FRYER'. Blue lines represent gas piping with flow values (e.g., 11982, 14178, 13729) and green lines represent ductwork. A yellow circle '3' highlights a specific area on the right side of the canvas.
- Status Bar:** At the bottom, it shows 'Scale: 100%', a '1 foot' scale bar, and 'Appliance Label Size'.

Below the screenshot, a blue text box states: **Selecting a new System, from the menu, will change the System of the current job**

FlashPoints uses a simple user interface that puts the tools you need right at your fingertips. The FlashPoints screen is

- 1) the [Menu](#)
- 2) the [ToolPanel](#)
- 3) the [Canvas](#)
- 4) the [Status Bar](#).

## 2.1. The Menu

File Edit View Help

The Menu is a normal Windows text menu that provides drop-down lists of features, options, and commands available within FlashPoints Suppression CAD.

Immediately below the Menu is a Menu Toolbar with shortcut buttons for commonly used items.

The Menus are arranged as follows:

|      |                                    |  |
|------|------------------------------------|--|
| File | Load or Start a Job                | Starts a new job or Loads a saved FlashPoints job from the database  |
|      | Save Job                           | Saves the current job to the database  |
|      | Print Drawing                      | Printout of the job drawing (uses credits)   |
|      | Print Drawing with Submittal Pages | Printout of the job drawing, notes, material requirements, and mfg specs (uses credits)                                      |
|      | Print Job Materials and Notes      | Printout of the notes and material requirements for a job.   |
|      | Print Job Costs Report             | Printout of the costs of materials, labor, discounts, taxes, and fees  |
|      | Print System Spec Sheets           | Print manufacturer specification sheets  |
|      | Import                             | Load data from an export file into the FlashPoints database.   |
|      | Export                             | Save the contents of the FlashPoints database to a text file.  |
|      | Exit                               | Ends FlashPoints and returns to the Windows desktop  |
| Edit | Copy a Job                         | Copy a job from another one customer to another, or from the same customer, rather than start from scratch                   |
|      | Delete a Job                       | Permanently delete a job from the database   |
|      | Delete a Customer                  | Permanently delete all of the jobs associated with a customer and all of the information for that customer from the database |
|      | Clear Canvas                       | Erase the drawing canvas   |
|      | Settings                           | Set filepaths and other default settings to customize FlashPoints  |
| View | Guidelines                         | Room Guide- display a room guide on the Canvas to make it easier to lineup the equipment in a drawing                        |
|      |                                    | Grid- display a graph paper-like grid on the Canvas  |
|      | Reframe Drawing                    | Reposition the entire drawing at the upper left corner of the drawing canvas.  |
|      | Automatic Placement                | Turn Automatic Placement on and off  |
|      | Job Settings                       | A submenu containing additional settings that can be applied specifically to the current job.                                |
|      | Language                           | Select the Language used to display all text in FlashPoints (currently English)  |

## 2.2. The Toolbar

### The Toolbar

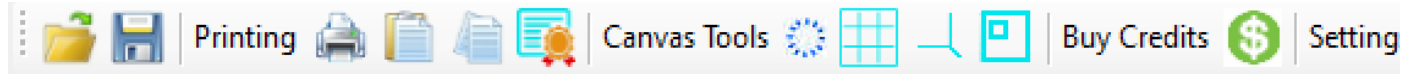

The Toolbar is designed to be a Quick Access Menu. Commonly used features of FlashPoint on the Toolbar can be accessed instantly for an improved user experience.

Simply click an icon and the feature will run, as if it were selected from the menus.

#### Toolbar icons:

- Load or Start a Job
- Save a Job
- 
- Print Drawing
- Print Notes and System Material List
- Print Specification Sheets
- Print Completion Certificate
- 
- Clear Canvas
- Toggle Grid
- Toggle Room Guide
- Reframe Drawing
- 
- FlashPointsStore (Buy Credits)
- 
- Settings
- 
- FlashPointsHelp (the manual)
- 
- About FlashPoints (license profile)

## 2.3. The Tool Palette

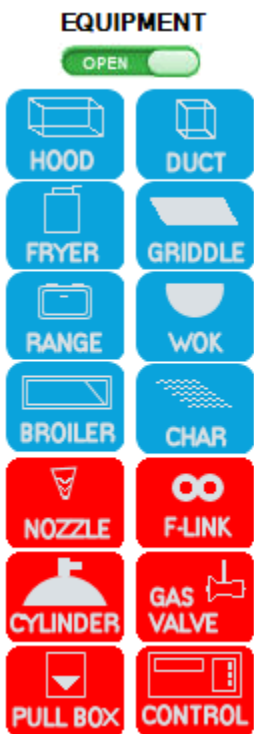

The Tool Palette is used to add a new item to the drawing canvas. Clicking one of the equipment buttons will create an object on the drawing palette that can be moved, changed, and manipulated. Each new object added to the drawing canvas will be displayed in the upper right corner of the drawing canvas. From there the object can be dragged, using the mouse, to anywhere on the drawing canvas. In this way, an entire kitchen can be laid out on the screen in a matter of minutes.

As each appliance is placed on the canvas, FlashPoints Suppression CAD will look up what types of nozzles are required and will use the Hazard Area dimensions of each object to determine the number of nozzles needed. The nozzles are placed on the drawing as needed. Nozzles will become visible on the canvas when an appliance has been unselected.

Any item on the equipment tab can be selected and modified at any time. If items overlap one another, it may be necessary to click in the same spot more than once. FlashPoints' Click-Thru™ technology allows it to cycle through each of the items in a particular part of the canvas, allowing you to select the one that you want. Simply keep clicking to highlight the appliance or protection item you wish to modify.

Each time an appliance is selected its color is changed to red and any nozzle that FlashPoints has placed over it are removed. When the item is unselected FlashPoints will change the appliance color to black and will once again display nozzles over that particular appliance. FlashPoints removes nozzles when an item is being moved or modified so that the protection can be recomputed if the dimensions or type of the appliance are changed.



## 2.4. The Canvas

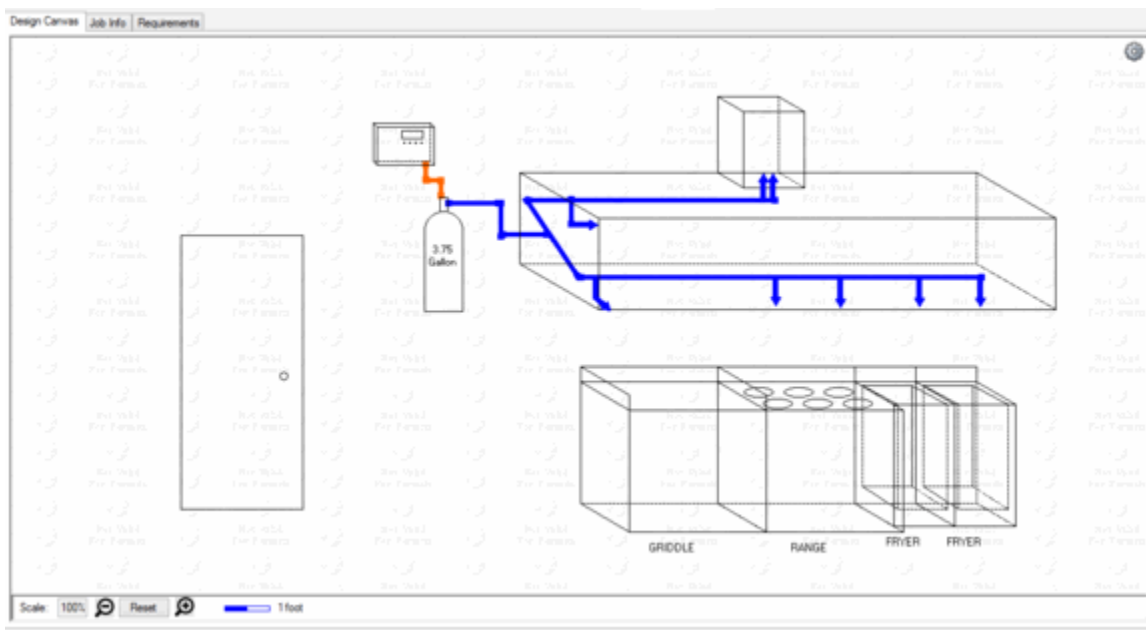

The Canvas is your workspace in FlashPointsSuppressionCAD. The drawing and system requirements for each job are entered on The Canvas. The Canvas is designed to be easy to use and completely customizable to meet all of your system design needs.

The Canvas has 3 tabs in the upper left corner: Design Tab, Job Info, and Requirements.

- The Design tab always returns you to the system drawing workspace.
- The Job Info tab replaces the drawing workspace with a form to enter information about the job. Here such information as the name and address of the customer, initials of the system designer, and miscellaneous job notes are entered.
- The Requirement tab contains an accounting of the job. Nozzles and Links from the drawing workspace are itemized, tanks and other equipment are chosen, and job costs are entered and computed on this screen. [Fire Equipment Dealer VERSION ONLY]

The toolbar at the top of the Canvas is an equipment toolbar. This toolbar is only visible when an equipment object is selected and highlighted in red on the drawing canvas. The equipment toolbar contains the following items:

- Equipment Item Name - FlashPointsSuppressionCAD displays this automatically. It represents the type of object currently selected.
- Equipment Style - Most equipment types have multiple styles to choose from. This drop-down list allows the designer to choose the desired style.
- Size - the dimensions of the selected item are displayed in inches and can be changed by clicking in one of the three boxes and typing a new value. As the dimensions are changed, the picture on the canvas will be changed automatically.
- Hazard Area - the hazard area is the surface area of the selected item that needs to be protected. These dimensions are used by FlashPointsSuppressionCAD to determine the number of nozzles needed to protect the item. If the Hazard Area is not properly defined, FlashPoints will not correctly compute the number of nozzles.
- Text Button - this is a toggle button that turns on and off the display of the selected item's name on the drawing canvas.
- Dimensions Button - this is a toggle button that turns on and off the display of the selected item's dimensions on the drawing canvas.

## 2.5. The Status Bar

**Protect your investment, order FlashPoints Drive Protection today.**

FlashPointsSuppressionCAD uses the Status Bar, at the bottom of the window, to display tips, information, and messages. Check this bar often for valuable information.

### 3. Starting a New Job

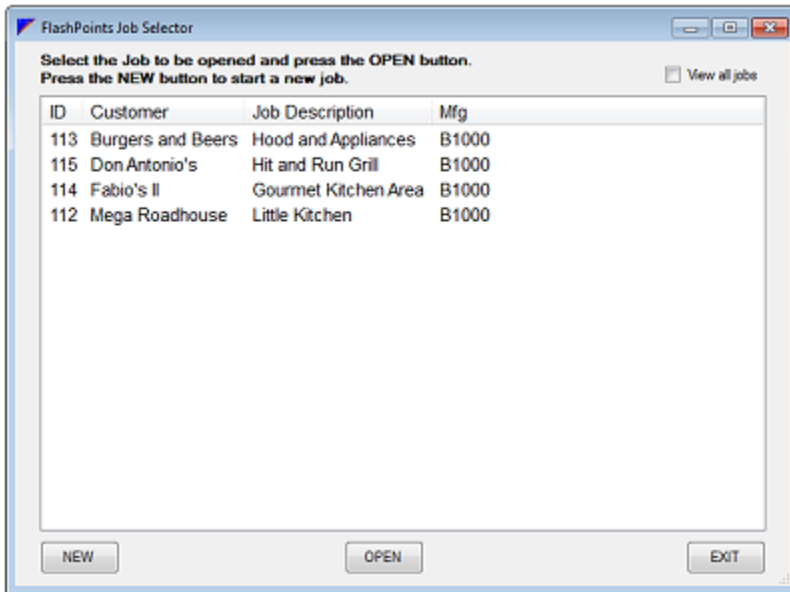

Each time FlashPointsSuppressionCAD is started it is ready to begin a new job. The drawing canvas and the job information are automatically reset when the program is started.

Select a customer name and job from the drop down list and click OPEN, or click NEW to enter a new customer and/or job.

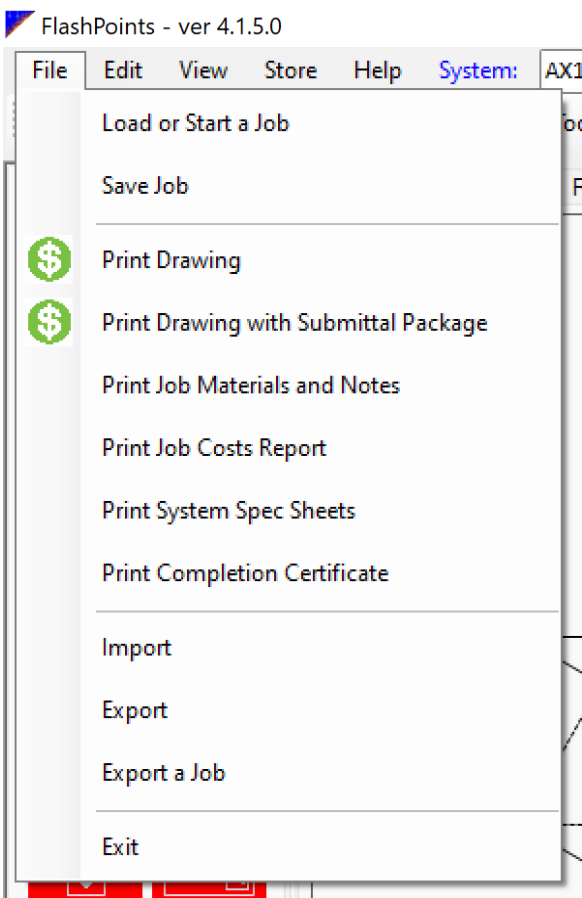

To begin a new job after you have been working on a job, select FILE | Load or Start a Job from the menu at the top of the screen. This will clear the drawing canvas and the job info, and will display the customer and job selection window shown at the top of this page.

NOTE: Remember to save your current job before starting a new one. If you forget to save a job, FlashPointsSuppressionCAD will remind you before loading a new one or exiting the program.

### 3. Starting a New Job

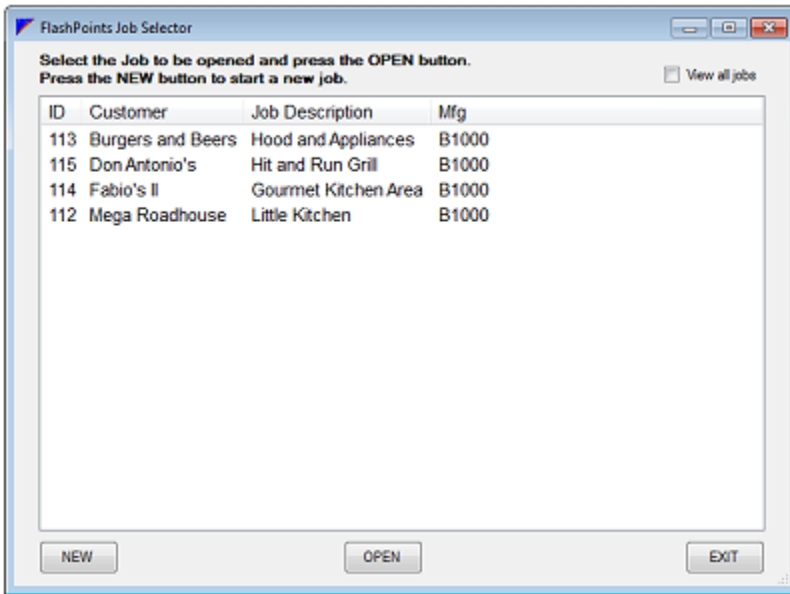

Each time FlashPointsSuppressionCAD is started it is ready to begin a new job. The drawing canvas and the job information are automatically reset when the program is started.

Select a customer name and job from the drop down list and click OPEN, or click NEW to enter a new customer and/or job.

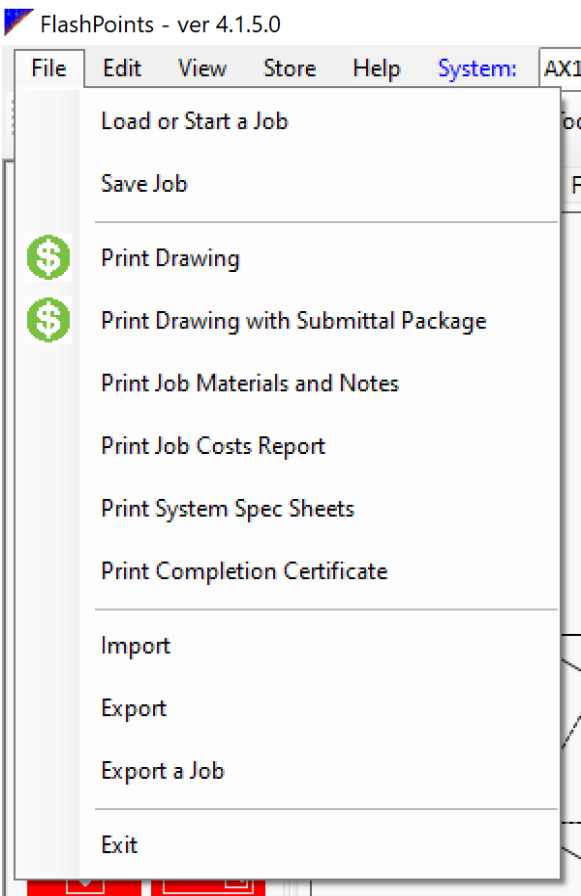

To begin a new job after you have been working on a job, select FILE | Load or Start a Job from the menu at the top of the screen. This will clear the drawing canvas and the job info, and will display the customer and job selection window shown at the top of this page.

NOTE: Remember to save your current job before starting a new one. If you forget to save a job

## 3.1. The FlashPoints Design Process

To create a FlashPointsSuppressionCAD job as quickly and efficiently as possible follow these simple steps:

- Draw the kitchen equipment or industrial space.
  - Use the pre-drawn objects to layout the equipment to be protected.
- Add additional nozzles and fusible links, if desired, to protect the kitchen equipment in your drawing.
- Piping and detection lines are added from the Piping Panel.
- Enter job information.
  - Notes, names, addresses, and designer initials are all entered on the Job Information screen.
  - Boilerplate notes are also available on the Job Info screen.
- Enter the job requirements.
  - Select cylinders, hangers, seals, and other equipment from the supplied database.
  - Enter job costs, fees, and miscellaneous items.
- Print Drawing

### 3.2. Printing a Job

FlashPoints reports are selected from the FILE menu. The Job Design Plan is only available when the Design Canvas Job Design Plan option is grayed out on the menu. The reason for this is to prevent a report from being printed with is printed, FlashPoints Suppression CAD takes a snapshot of the drawing canvas and sends the snapshot to the print

The Job Design Plan is the report that prints the drawing, design notes, and a list of job materials. This report is also Fire Marshall's require a system design plan prior to installation. [To ensure that a drawing is visible on the screen, F tab be clicked before the Job Design Report can be printed.] An authentication watermark is added to all FlashPoi

The Job Cost Report (not available in the Fire Scene and AHJ versions) is a Bill of Materials for the job. Materials this report.

When a report is printed, it is first displayed on the screen as a print preview. The print preview is useful for saving printer might not be available. Clicking the printer icon on the print preview will open the printer setup display. This and other printer functions (such as specifying the number of copies). When the Print button is clicked on the printer The printer setup icon is labeled 'A' on the image below.

Clicking on the page setup icon opens the page setup display. Paper size can be selected from the page setup display image below. FlashPoints reports can be printed in a variety of sizes, including 8 1/2 x 11, 8 1/2 x 14, and 11 x 17.

For best results, select the page size from the page setup screen, then open the printer setup display to choose the p

All FlashPoints reports are intended for the system installer's internal use. It is NOT recommended that any of these

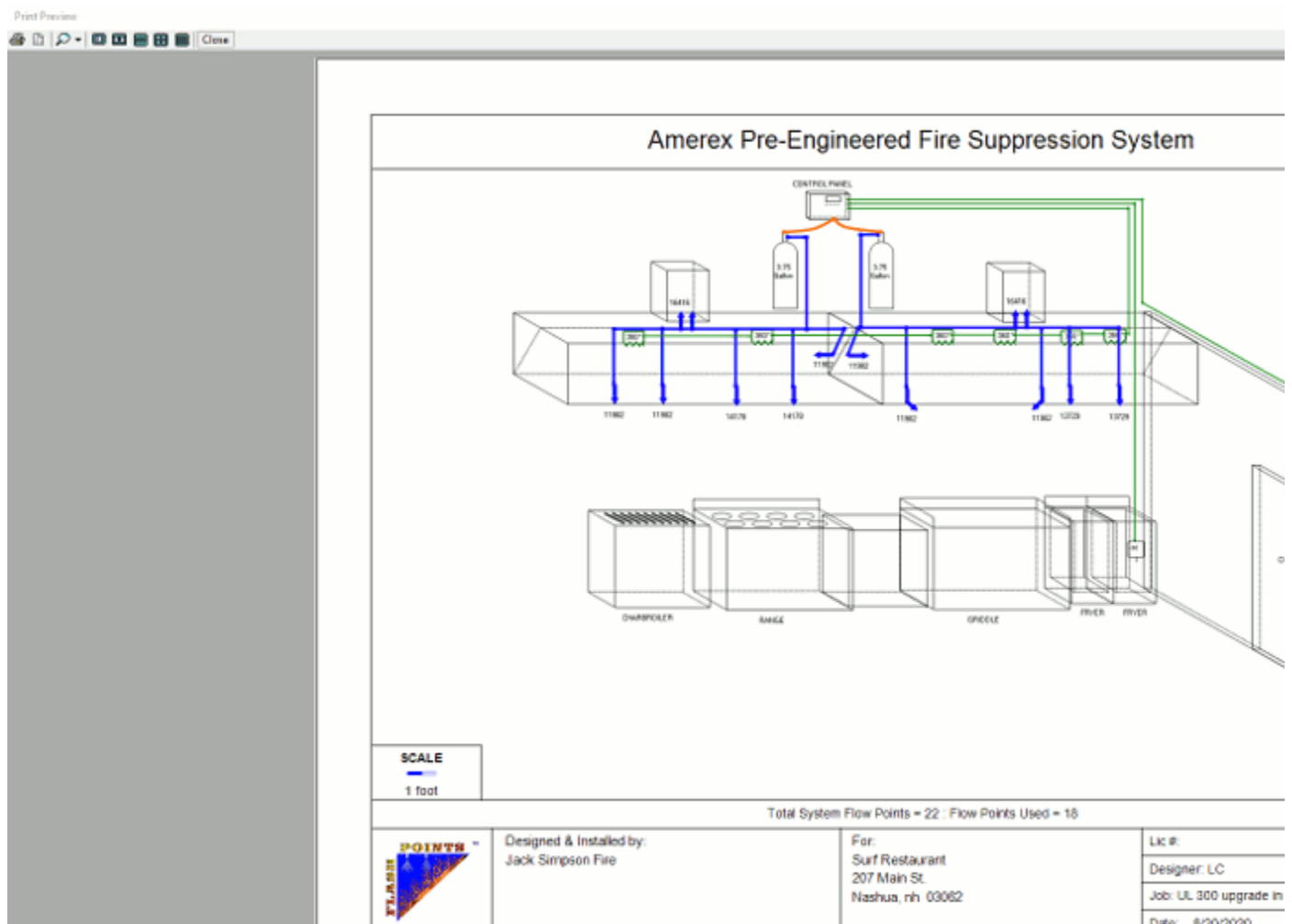

## **3.3. Saving a Job**

Computers are unpredictable and saving your work is an essential part of using any computer program.

Select **FILE | Save** to save the current job to the database.

If a new job is loaded or the program is exited without saving the current job, FlashPointsSuppressionCAD will pop up a window that will ask if you want to save the current job, before you leave it.

## 4. Making a Drawing

All FlashPointsSuppressionCAD projects begin with a drawing. Drawing the layout of the equipment to be protected helps the designer conceptualize the job and provides FlashPoints with the necessary information to compute the necessary protection.

Making a drawing in FlashPoints is easy. Simply select the objects from the Tool Palette and drag them around the screen to assemble the picture. Other drawing programs provide the tools to draw each object from scratch, but they also require a lot of artistic talent. The predefined shapes provided by FlashPoints reduce the tedium of drawing and allow the designer to focus on the "big picture".

When working with FlashPoints drawings there are some basic functions to remember:

- Click on an object to select the object. The object will change from black to red to indicate that it has been selected and the [Minibar](#) will be displayed next to the image.
- Click on a selected object to unselect it. The [Minibar](#) will disappear and the color of the image will change from red to black.
- Only the selected object can be moved, resized, deleted, rotated, or otherwise manipulated.



## 4.1. Starting with a Hood

Since all kitchens require a hood, this is the best place to begin when creating a FlashPointsSuppressionCAD kitchen drawing. Press the HOOD button  on the Tool Palette to add a hood to the drawing canvas. The Tool Bar above the drawing canvas will instantly change to show the options available for the new hood.

The type of hood can be selected from the drop-down list at the left of the menu bar. FlashPoints has several types of hoods to choose from: Sloped, Box, Low Clearance, and Island. Selecting a hood type will instantly change the picture of the hood displayed on the canvas to the selected style.

Move the hood to the desired location on the canvas by clicking on the picture of the hood, holding down the left mouse button, and dragging the picture around the canvas. Release the mouse button to drop the hood. The arrow keys on the keyboard can also be used to move the hood.

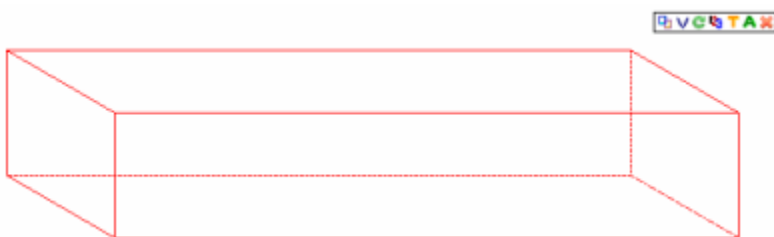

The size of the hood can be changed by typing new values for the three dimensions in the menu bar. Click in any of the three text boxes to change the value of the dimension. As the length, width, and height are changed the image on the canvas will instantly change. (Note: Click the Convert button to toggle the units between inches and feet.) If an entered dimension would cause the appliance to extend past the edge of the canvas, the dimension is automatically changed to the value it was before any changes were made. In addition, the value of the dimension can be reverted to its original setting by pressing the ESCAPE key on the keyboard.

The hazard area of the hood is determined by the Hazard Area values in the menu bar. The length and width of the hazard area are used to determine the number of nozzles required to protect the area. The hazard area values are changed each time the size of the hood is changed. The hazard area may be set independently of the size of the hood, if required. However, bear in mind that each time the size of the hood is changed the hazard area will be changed to match the size dimensions. The hazard area dimensions are provided as an "override" to the size dimensions so that the actual hazard area can be specified by the system designer.

Once the hood has been placed on the canvas it can be annotated using the TEXT and DIMENSIONS buttons. The TEXT button will toggle the display of the hood type under the picture of the hood. Click on the text and drag it to the desired location. Text can be moved to any position on the appliance. Text can only be moved while an appliance is "selected".

The DIMENSIONS button will toggle the display of the length, height, and width values on the picture of the hood.

Finally, the [Minibar](#) attached to the upper right corner of the hood image can be used to rotate the hood sideways or to remove the hood from the canvas. For more information about the Minibar see the [MiniBar topic](#).

## 4.2. Drawing Ducts

Ducts are an essential part of any ventilation system. FlashPointsSuppressionCAD makes it simple to add ducts to your drawings. Round and square ducts are available by pressing the DUCT button on the tool palette.

By combining duct segments with different height and width dimensions it is possible to make some interesting drawings. For example, a duct with a long height dimension set on top of a duct with a long width dimension could be used to represent a duct that bend upward. Move the taller duct to the middle of the other and a T shaped configuration can be drawn. See the images below for some examples of possible ductwork.

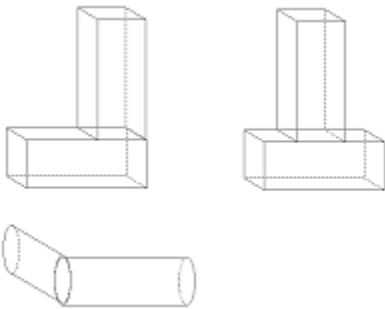

In addition to standard ductwork, FlashPoints also recognizes Upper Plenums. To create an Upper Plenum, start drawing a duct and choose the Upper Plenum type. This will allow FlashPoints to compute the necessary protection based on the manufacturer's rules for Upper Plenum coverage.

NOTE: Upper plenums and upper ductwork do not normally require protection, but FlashPoints may protect these areas. If this protection is not necessary, use the [Minibar](#) on each nozzle to remove the nozzle from the drawing.

## 4.3. Adding Appliances



Use the six appliance buttons to add appliances to your drawing. Fryers, griddles, tilting skillets, ranges, woks, broilers, and charbroilers may all be added to your drawing with just a few mouse clicks.

Appliances are added to your drawing exactly the same way that hoods and ducts are:

1. Select the appliance type.
2. Set the appliance dimensions.
3. Set the appliance hazard area.
4. Move the appliance into position.

All appliances are available in front view and side view to make it easy to layout a corner kitchen.

A text label and dimensions can be added to any appliance on the screen. But be careful, adding too much text to the screen will make the drawing look busy and difficult to understand. Text and dimensions should only be added to the drawing if they are absolutely necessary.

## 4.4. The Minibar

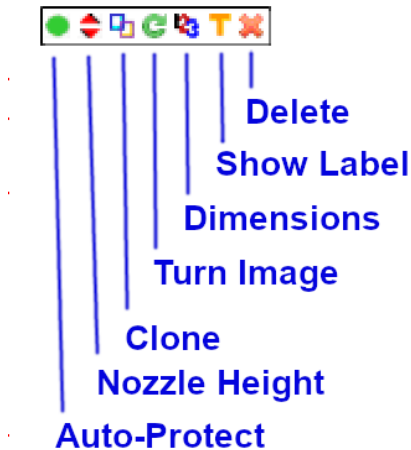

The Minibar is a collection of tools that are available for each object on the screen. The Minibar remains invisible until the mouse pointer is moved onto a selected item. When an item is selected the Minibar appears just above the top right corner of the object. Placing the mouse pointer over any of the Minibar buttons and letting it hover will cause a tooltip message to be displayed. The tooltip will identify the function of the Minibar button.

For non-protection items (appliances and equipment), the Minibar provides 6 valuable functions:

**AUTOPROTECT TOGGLE** - (appliances only) turn autoprotect on and off.

**NOZZLE HEIGHT TOGGLE** - (appliances only) turn the nozzle height label on and off.

**CLONE** - clicking on the CLONE tool will create another object exactly like the currently selected item. This is useful for creating multiple appliances in a drawing that are exactly the same. For example, you might need to draw eight hibachi grills in a Japanese restaurant, each turned sideways with special dimensions. After the first one has been setup, the clone button can be used to produce each of the other grills. Cloned items appear in the upper left corner of the drawing canvas.

**TURN** - click the TURN button to toggle the selected image between front view and side view. The side view is an isometric representation of the object turned 90 degrees to the left.

**SHOW DIMENSIONS** - display the height, width, and depth of the selected object (in inches) on the drawing.

**SHOW LABEL** - display the name of the selected object on the drawing.

**DELETE** - to remove the selected item from the drawing canvas, click the DELETE button. This action cannot be undone. Only click the DELETE button when you are sure you want to permanently remove the selected item from the drawing canvas.

For Hoods ONLY:

**DISPLAY FILTER** - toggles a filter bank on and off inside the displayed hood. In the case of an Island Hood, the filter bank is a V-Bank, centered inside the hood.

For protection items (nozzles and fusible links), the Minibar only provides 4 functions:

## 4.5. Keyboard Shortcuts

For your convenience, several keyboard keys can be used as shortcuts when working in FlashPoints:

**ESC** - when drawing pipe the ESCAPE key can be used as a "start over" key. After the first point has been clicked and a red circle is on the canvas, pressing ESCAPE will remove the red circle and reset the drawing mode to start a fresh pipe segment.

**DELETE** - pressing DELETE will remove the currently selected item from the canvas (equipment or pipe). This is the same as using the X on the Minibar.

**ARROW KEYS** - the LEFT, RIGHT, UP, and DOWN ARROW KEYS can be used to move the currently selected item. Each time one of these keys is pressed the item is moved one pixel in the key's direction. This is a good way to "fine tune" the placement of items on the canvas.

**CTRL** - holding down the CONTROL KEY while drawing pipe will force FlashPoints to draw the pipe segment as a diagonal piece of pipe. This overrides the default horizontal/vertical pipe drawing.

## 4.6. Automatic Placement

With Automatic Placement, FlashPoints tries to place appliances and ducts where they belong. Instead of placing new appliances in the upper left corner of the drawing canvas, Automatic Placement centers ducts above the hood and places appliances next to each other under the hood.

At least one hood has to be on the drawing canvas for Automatic Placement to work. Each appliance added to the canvas will be placed under the hood starting from the right side of the hood. Each subsequent appliance is aligned to the left of the appliance before it.

Automatic Placement can be turned off and on by clicking the menu option under the Tools menu. For complex drawings with multiple hoods it might be a good idea to turn off the Automatic Placement feature. When Automatic Placement is turned off, each appliance or duct added to the drawing will be placed in the upper left corner of the drawing canvas.

Automatic Placement only computes the beginning location of each appliance. The mouse and arrow keys may be used to move objects on the drawing canvas to any desired location.

## 4.7. Selecting Items

When working on a drawing, FlashPoints Suppression CAD follows a very simple rule: Only one object can be worked with at a time. It doesn't matter if the object is an appliance or a protection device, all objects must be selected before anything can be done with them and only one object may be selected at a time.

To select an object, simply click on it. Clicking on an object that is not selected will change the color of the object from black to red and will change the menu bar to the appropriate information for the newly selected item.

Selected items can be dragged around the screen, resized, turned, annotated, or deleted.

To unselect an item, simply click on it. Clicking on an object that is selected will change the color of the object from red to black and will clear the menu bar.

A fast way to switch from one object to another, after you have selected an object, is to click on another (unselected) object. This will unselect the old object and select the new object in a single click.

Objects that are covered, or overlapped, by other objects can be selected using FlashPoints' Click-Thru™ technology. Each time an image location is clicked the objects at that location will be selected and deselected in turn. Cycling through the objects will eventually select the desired object. In other words, just keep clicking in the same spot until the desired object is selected.

## 4.8. Scaling the drawing

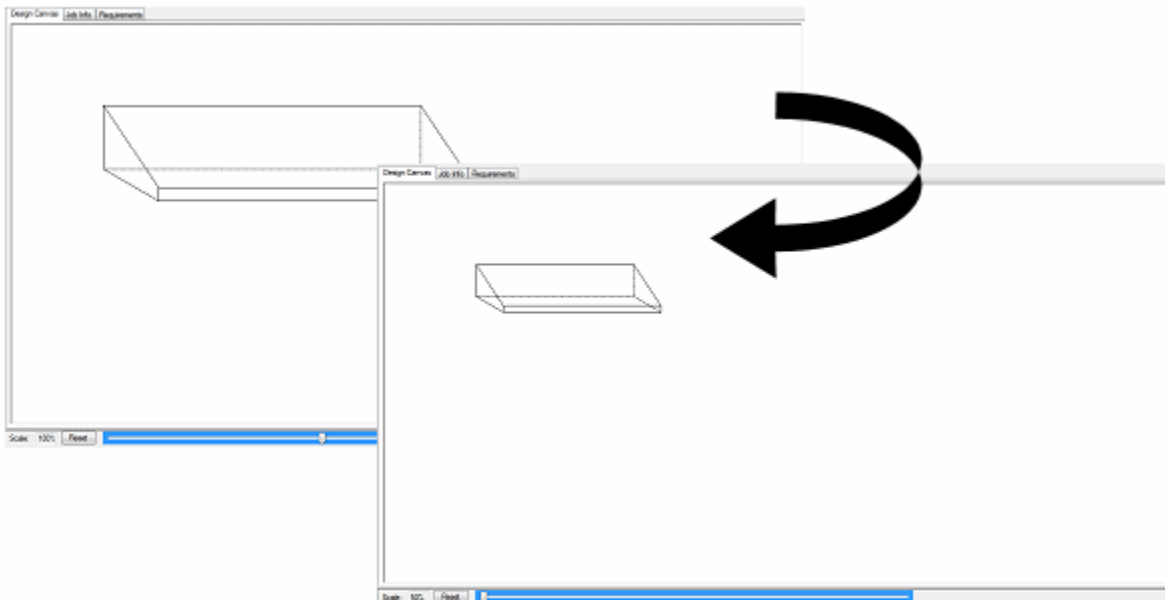

Occasionally it will be necessary to change the size of the objects on the canvas to make room for more items. The objects on the canvas can be scaled up or down using the slider bar located just below the drawing canvas. Sliding the bar to the left will make the items on the canvas smaller. This will allow more objects to be displayed on the canvas. Sliding the bar to the right will make the items on the canvas bigger. This will fill up the canvas with just a few objects.

Resized objects can be returned to their original size by pressing the RESET button to the left of the slider bar.

Scaling has no effect on text size. Text size can be changed in the Job Settings window, if necessary.

**NOTE:** Because appliances and piping are drawn differently, it is strongly recommended that drawings containing pipe NOT be scaled after the pipe has been added.

## 4.9. Reposition Drawing

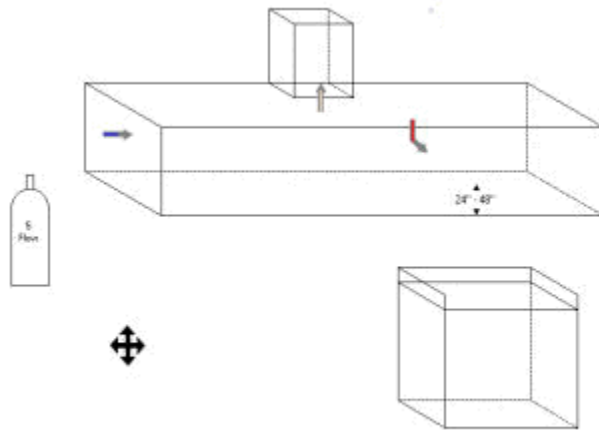

The entire drawing can be repositioned on the Canvas by clicking on an empty part of the canvas and dragging the mouse in the direction that the drawing is to be moved. When an empty part of the Canvas is clicked, the cursor will change into a four-point move icon. While holding the mouse button down, drag the mouse around and the entire drawing will move around with it.

If the drawing is moved off of the canvas, it can easily be recovered. Under the VIEW menu, click the menu item called

REFRAME DRAWING. This will reposition the drawing at the top left corner of the Canvas.

Use the LEFT mouse button (a normal click) to move the entire drawing around on the screen. Use the RIGHT mouse button to move just the pipe on the screen. The ability to move just the pipe is very useful if the pipe should happen to move out of place on the drawing (this can happen when scaling a drawing).

## 4.10. Labels and other Job Settings

Job Settings can be found under the VIEW menu.

FlashPoints Suppression CAD makes labeling drawings a breeze. The Minibar can be used to turn labels on or off for each item on the drawing, or the Job Settings panel can be used to turn labels on or off for all items.

The Show Protection Labels checkbox will toggle all labels on protection items.

Please note that if a few labels have been turned on using the Minibar, these checkboxes will override their settings. Similarly, the Minibar can be used to override the settings of these checkboxes. For example, if all appliance labels except one should be turned on, check the Show Appliance Labels checkbox, then use the Minibar for the one appliance to be turned off.

Nozzle Height labels, Nozzle Height label decorations, and Text Item decorations can be turned on and off using the appropriate checkboxes.



## 4.11. Moving Labels

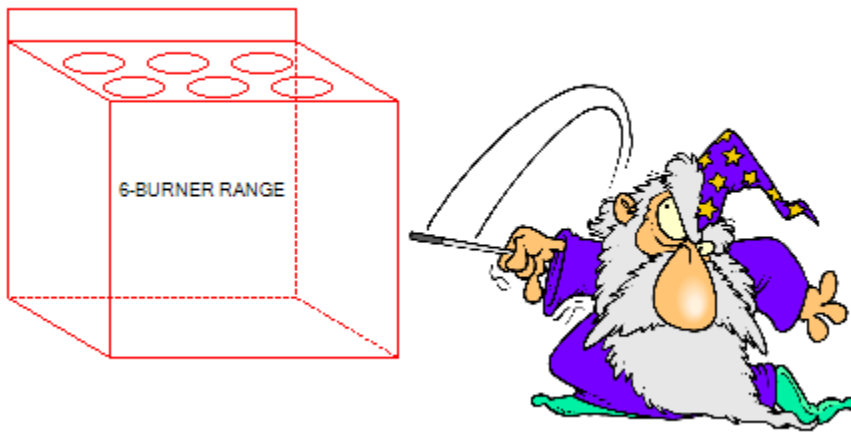

By default, appliance and protection labels appear below each item. However, labels can be moved anywhere on or around an object.

To move a label, click on the object to select it (it will turn red). Then click and drag the label to the desired position.

Unselect the item to lock the label into the new location.

At any time the item can be selected again and the label can be moved to a new location.

## 4.12. Nozzle Height Labels

Nozzle Height Labels can be toggled on or off using the icon provided on the Minibar of most appliances. A setting in the Preferences screen can be used to toggle the display of Nozzle Height Labels off and on. Also, an option in the Job Settings window can be used to turn the Nozzle Height Labels on and off for the current job.

As with other objects on the Flash Points Suppression CAD drawing canvas, Nozzle Height Labels have several features built into them. Nozzle Height Labels can be selected by clicking on the arrows above and below the label text. Once selected a Nozzle Height Label can be moved by dragging it with the mouse.

Text on Nozzle Height Labels can be changed by double clicking on the text. The text will turn into a textbox that can be changed. To exit change mode, simply click on one of the arrows of the Nozzle Height Label or unselect the Nozzle Height Label by selecting another object.

Nozzle Height Labels share the same font settings as other labels on the drawing. When the font size is changed by the font size tool on the Job settings window, the size of the Nozzle Height Label text will change accordingly.

If the scale bar, at the bottom of the drawing canvas, is used to scale the drawing, the arrows on the Nozzle Height Label will scale with the rest of the drawing. However, as with other labels, the text will not scale unless the font size tool in the Job settings window is used to change it.

## 4.13. Add an Image

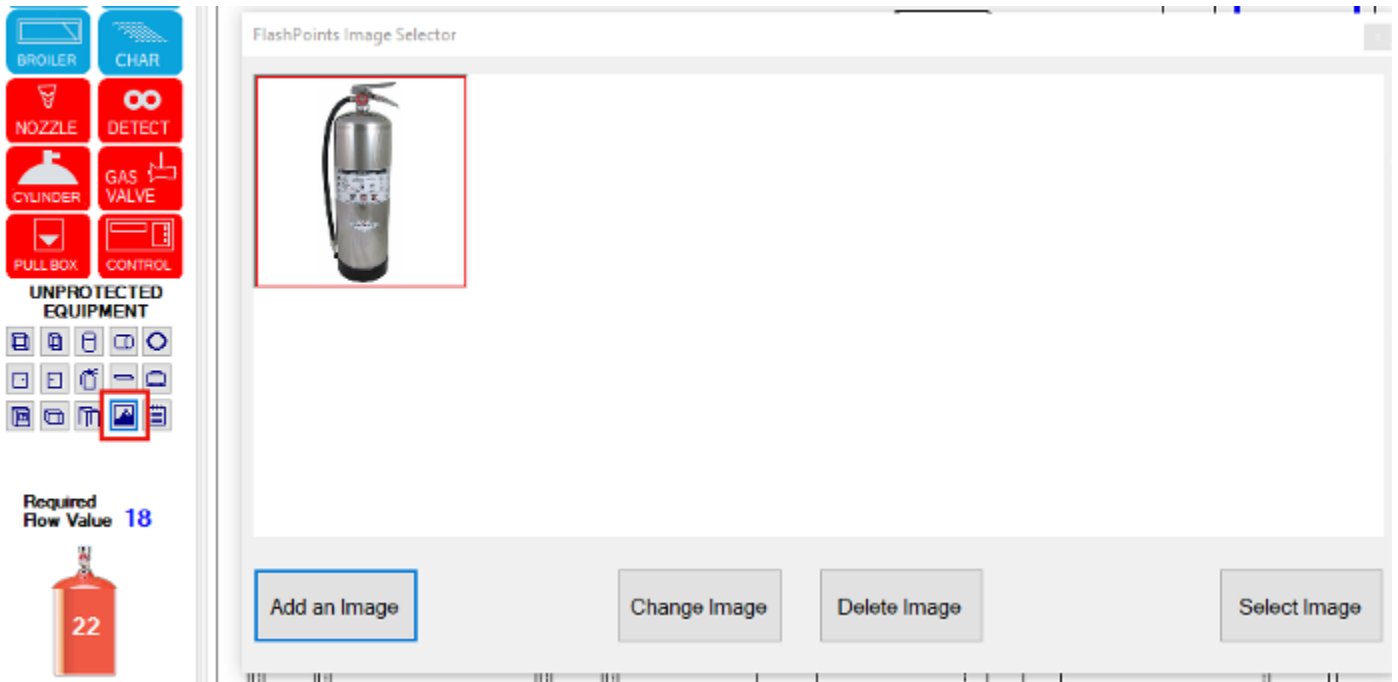

Click the **IMAGE** button, in the third row of the Unprotected Items buttons on the tool panel, to add an outside image to a drawing. The FlashPoints Image Selector will open. Any images currently stored in FlashPoints will be displayed in this window and will be available to use in a drawing. If there are no images available, a message will be displayed in the large window that says, "No Images Available".

Add images to FlashPoints using the Add an Image button. This will store an image in the FlashPoints database and it will appear in the selector window. Images added to FlashPoints are available for use in other drawings.

Click on an image to Change it, Delete it or Select it.

When an image is selected using the Select Image button the image will be displayed on the canvas. A red border will appear around the image to indicate it has been selected. The canvas image follows the same rules as other canvas items. It can be dragged and it has a Minibar that can be used to resize the image, display a label, or remove the image from the canvas.

## 4.14. Text Notes



Notes can be added to the drawing canvas using the Notes button beside the Unprotected Items buttons on the tool palette.

Text Notes can be selected by clicking on the text of the Note. Once selected the note can be moved to any location on the drawing canvas.

To change a text note, double click the text and enter the new text. If the new text is longer than the current note text, the Text Note will be resized automatically. There is, however, a limit to the size of the text note. When this limit is reached the note will be truncated at that point. The size limit varies with the size of the text font.

Multiple line text notes can be created by pressing the ENTER key at the end of each line. A new line will be added to the note so more text can be added on the next line. Paragraphs are created by pressing the ENTER key twice. This leaves a blank line in the note to separate the paragraphs.

Text Notes have a Minibar that appears when a selected Text Note is moused over. This Minibar features the same delete button as other Minibars. To remove a text note from a drawing click the delete button in the Minibar.

The text in Text Notes can be resized using the font size tool in the Job Settings window. The Text Note will resize along with other text on the drawing.

Multiple Text Notes can be placed on the drawing and arranged as desired to form blocks of text or a variety of comments and notes.

## 4.15. Using Room Guides

FlashPointsSuppressionCAD provides two sets of guides to assist with creating professional drawings.

The Room Guide displays 3 light blue lines on the drawing canvas. The 3 lines represent the corner of a room. To layout a kitchen, place appliances along the lines.

Grid Guidelines are available for people who prefer to work on graph paper. The evenly spaced light blue lines make it easy to align objects with each other. Each square in the grid represents 1 foot. The grid automatically adjusts when the drawing is scaled.

Both guides are accessed by selecting **VIEW | GUIDELINES** from the Main Menu at the top of the screen. The menu selections for the guides act as toggles. Click once to turn on a guide, then click again to turn it off. Clicking the other guide when one is in use will switch to the other guide.

**A NOTE ABOUT PRINTING:** When FlashPoints prints a drawing it takes a snapshot of the image on the screen. Anything on the canvas, including guidelines, will be included in the printout. For this reason, it is a good idea to turn off any guidelines before printing a job.

## 4.16. Protecting the Appliances

When a selected appliance is unselected, FlashPoints CAD will use the information provided by the drawing to determine the type and number of nozzles needed to protect the equipment in the drawing. FlashPoints will only add nozzles automatically if fusible links must be added to the drawing by using the FLINK button. If a nozzle is not displayed in the correct location, simply click on it and move it. If too many nozzles are on the screen, click on the ones to be removed and delete them.

Additional nozzles and fusible links can be added to the drawing by pressing the NOZZLE or FLINK buttons. The type of each nozzle or fusible link can be specified and it can be moved to any position on the drawing. The MiniBarT button can also be pressed to toggle the display of the type of nozzle on the drawing.

### Existing Protection

When designing a system upgrade to an old or existing system, there will often be equipment that can be reused. To mark a nozzle as existing, click the EXISTING button on the nozzle's [Minibar](#). FlashPoints will redraw the nozzle using dashed lines to indicate that it is existing. The existing nozzle will be shown on the final report, but it will be removed from the overall cost of the job since it is being reused.

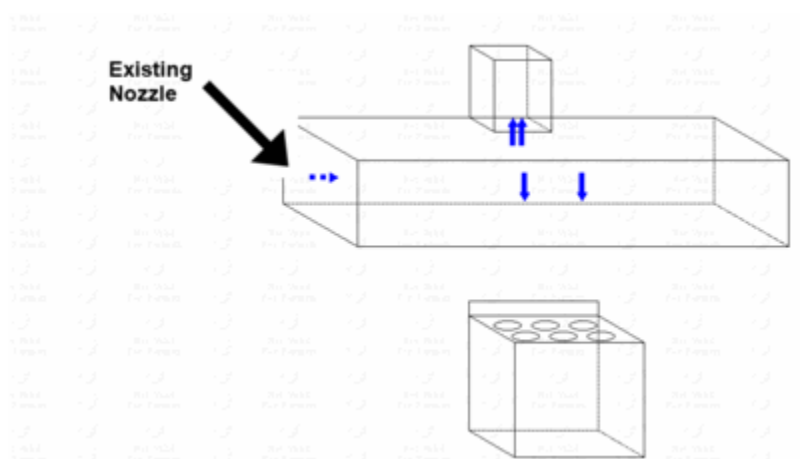

**NOTICE:** Please remember that FlashPoints is meant to be a tool to assist in the design of fire suppression systems. It is not meant to replace the knowledge and expertise of a trained fire suppression professional. Although FlashPoints will attempt to provide accurate results, the fire suppression system designer/installer is ultimately responsible for the final system design. Every effort has been made to make FlashPoints flexible and user-friendly. If information or documents, produced by FlashPoints are not correct, it is the designer's responsibility to correct any errors prior to system installation. Flash-Soft, LLC shall not be liable for improper fire suppression system design and/or installation.

### 4.16.1. Specifying Adequate Protection

A cylinder is displayed in the Tool Panel on the left side of the screen. This cylinder is a gauge that keeps track of the protection flow values (nozzles) on the drawing and the flow value of the cylinders. When enough cylinders have been specified to satisfy the flow value of the nozzle the cylinder-gauge will appear full and will show the total flow value on it.

There are two ways to specify protection in FlashPoints Suppression CAD. One way is to place protection items on the drawing canvas. The other way is by using the Requirements screen [Fire Equipment Dealer Version Only], which will be explained later. Objects specified on the Requirements screen do not appear on the drawing canvas. This is a handy way to specify items for a job without showing them on the drawing.

Copyright © 2022 Flash-Soft, Inc.

### 4.16.2. Overriding Protection

By default, FlashPoints uses Automatic Protection to compute the nozzles needed to cover an appliance. This means that when a selected appliance is unselected FlashPoints will compute the type and number of nozzles necessary to provide coverage and will display them on the canvas.

A toggle button has been provided on the Minibar of each appliance that allows the Automatic Protection of the appliance to be turned off and on. When the button is green, Automatic Protection is turned on. When the button is red, Automatic Protection has been turned off. In the off position, FlashPoints will NOT calculate nozzle coverage and will NOT display nozzles automatically. With Automatic Protection turned off nozzles can be placed manually over an appliance to override FlashPoints' protection.

When Automatic Protection is turned off, an appliance's nozzles are "sticky". They stay where they are positioned and the type of nozzle is not changed by FlashPoints if the item is resized or moved. In fact, moving the appliance across the page brings the nozzles along for the ride, too! Nozzles can also be added to Miscellaneous items and Images to protect user drawn items that require coverage.

With the Automatic Protection toggle on each appliance's Minibar, the setting of Automatic Protection can be set for each appliance, individually. The value of the setting (on or off) is saved for each appliance in the FlashPoints database.

Copyright © 2022 Flash-Soft, Inc.

## 4.17. Locking Appliances



FlashPoints' "Click-Thru" technology makes it easy to select items that are stacked on top of each other, such as nozzles and ducts. Usually, if an appliance is selected and unselected, FlashPoints will simply remove and redisplay the protection as it was originally. However, if the dimensions of an appliance are changed, if the type of appliance is changed, or if the appliance is moved, FlashPoints will reset the appliance's protect and remove any changes that have been applied. To move protection items (nozzles and fusible links) without selecting appliances, lock the appliances.

Click the Slide Lock at the very top of the Appliance Tool Panel. This will disable all of the appliance buttons and will prevent the selection of any appliances on the drawing. Now nozzles, fusible links, shelves, and other items can be selected and rearranged with ease.

When done working on Protection and Miscellaneous items, or if new appliances need to be added to the drawing, Click the Slide Lock to "open" it. This will reenable the appliance buttons and allow appliances to be selected again.

## 4.18. Adding Other Objects

In addition to appliances and protection objects, FlashPointsSuppressionCAD provides other objects that might be needed to fill-out a drawing. With a little imagination these objects can be used to add cabinets, tables, counters, columns, rods, doors, and walls to a drawing.

FlashPointsSuppressionCAD is able to distinguish between appliances and other objects so that it only applies protection to the objects that need it.

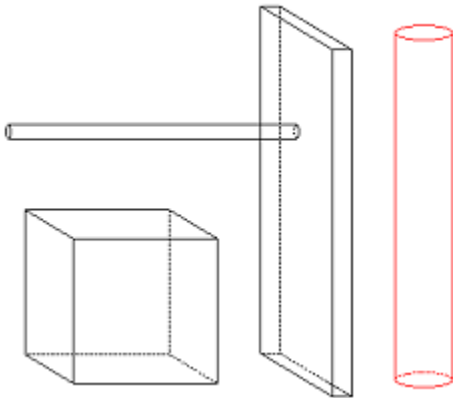

Here are just a few things that can be drawn using FlashPointsMiscellaneous objects:

**Windows:** Using the cabinet object, set the depth to 0 and set the width and height to the proper dimensions. Then change the text label to “WINDOW”.

**Duct openings and access panels:** Using the cabinet object, set the height to 0 and set the width and depth to the proper dimensions.

**Walls:** Using the square column, set the depth to 3, the width to 48, and the height to 96. Turn it to the side and you have a wall. Reduce the height to 36 inches to create a kneewall.

With a little imagination these tools can be used to draw control boxes, cylinders, pull stations, gas valves, smoke houses, bread ovens, toasters, floor plans and many other items.



## 4.19. Using Guides

FlashPointsSuppressionCAD offerstwo kinds of guidesto assist withscreen layout. Each guideis designed to be a background patternand willautomaticallybe removed fromthe drawingbefore printing. Both guides can be accessed fromthe menubar, under the VIEW tab. Onlyone type of guidecan be activeat a time. Selecting one guidewillturnoffthe other guide. Selectingthe activeguidewillturnoffallguides.

The Grid is simulatedgraph paper. Each square represents a foot or a meter, dependingupon the measurement system inuse:

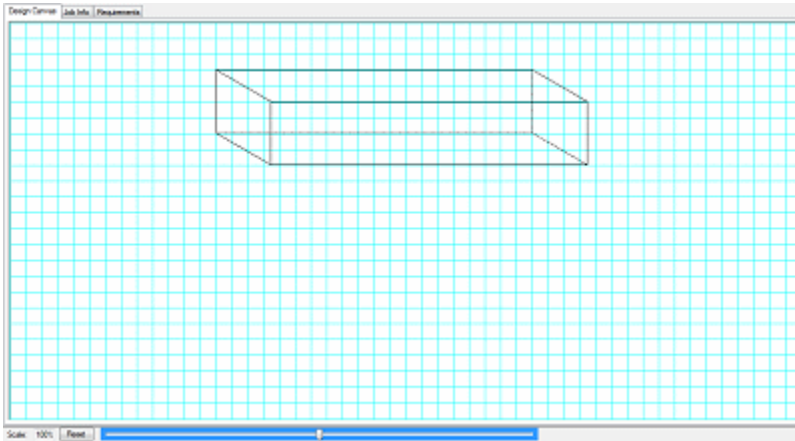

The Room Guide is an isometricrepresentationof the rightcorner of a room:

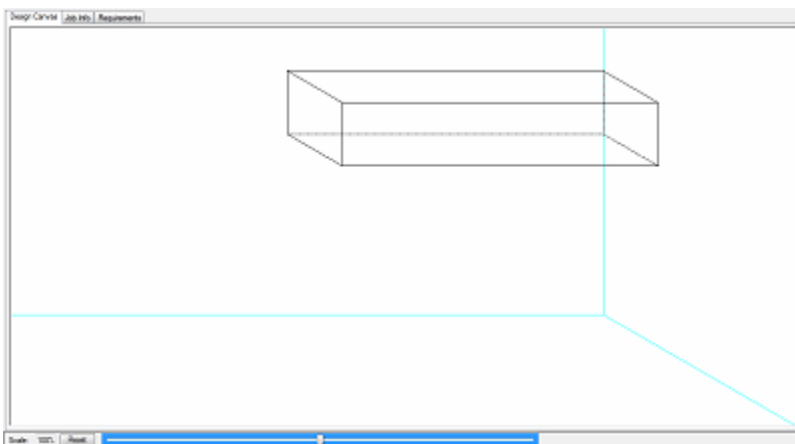

## 5. Entering Job Information

The Job Information tab provides a place where descriptive information about a job and job notes can be entered. Click the Job Information tab above the drawing canvas to remove the drawing canvas and replace it with the Job Information screen.

### 5.1. Customer Information

Customer information, such as name and address, will be printed on all reports that FlashPoints Suppression CAD produces for a job. The customer information screen is also a good place to store customer contact information too. All customer information entered on the screen will be saved with the job.

To enter or change customer information, click the EDIT button. After making the desired changes, click the SAVE button.

### 5.2. Job Notes

The Job Notes area on the Job Information screen is a "free form" text box where any and all notes and miscellaneous information about a job can be entered. Comments entered in the Job Notes box will be printed on the data sheet that prints with the drawing. Please remember that there is a 4000 character limit to these notes. Anything entered after 4000 characters will be excluded from the job notes.

Examples of some Job Notes:

"Installation must conform to the manufacturer's specifications and guidelines."

"All nozzles will be hand-tightened prior to system inspection. Fire Marshal will tighten each nozzle as inspected."

Boilerplate job notes have been provided to speed up the entry of job notes. Simply check the box next to each pre-written note to add it to the job. To view the text that will be printed on the final report, click on the title of the note. The full text of the note will be displayed in the preview area. To include all boilerplate notes, click the Check All button. To remove all boilerplate notes, click the Uncheck All button.

In addition to Job Notes, the NOTE button on the design Canvas toolbar makes it easy to put paragraphs of text directly on the drawing. In addition, text notes can be enlarged and reduced as needed. An option on the Minibar of the note allows you to surround text notes with a box.

## 5.3. Job Identification

Space is provided on the Job Information screen for a job identification number and the initials of the designer(s) of the job. This information will be printed on the bottom of the drawing.

To enter or change the job identification information, click the EDIT button. After making the desired changes, click the SAVE button.

## 5.4. Installation Company Information

Space is provided for the entry of Installation Company information. However, this is NOT a place to enter the company information of the FlashPoints licensee. When each copy of FlashPoints is activated, the name and address of each licensee is automatically transferred to FlashPoints. There is no need to enter YOUR company name and address.



FlashPoints customers are allowed to make drawings and sell them to other fire equipment companies. The purpose of this section is to enter the name and address of ANOTHER company. When drawings are made for other companies, FlashPoints blocks the licensee's name, address, and logo and replaces them with the name, address, and logo provided in this space.

**ONLY ENTER INFORMATION IN THIS SECTION IF YOU ARE MAKING DRAWINGS FOR ANOTHER FIRE EQUIPMENT COMPANY.**

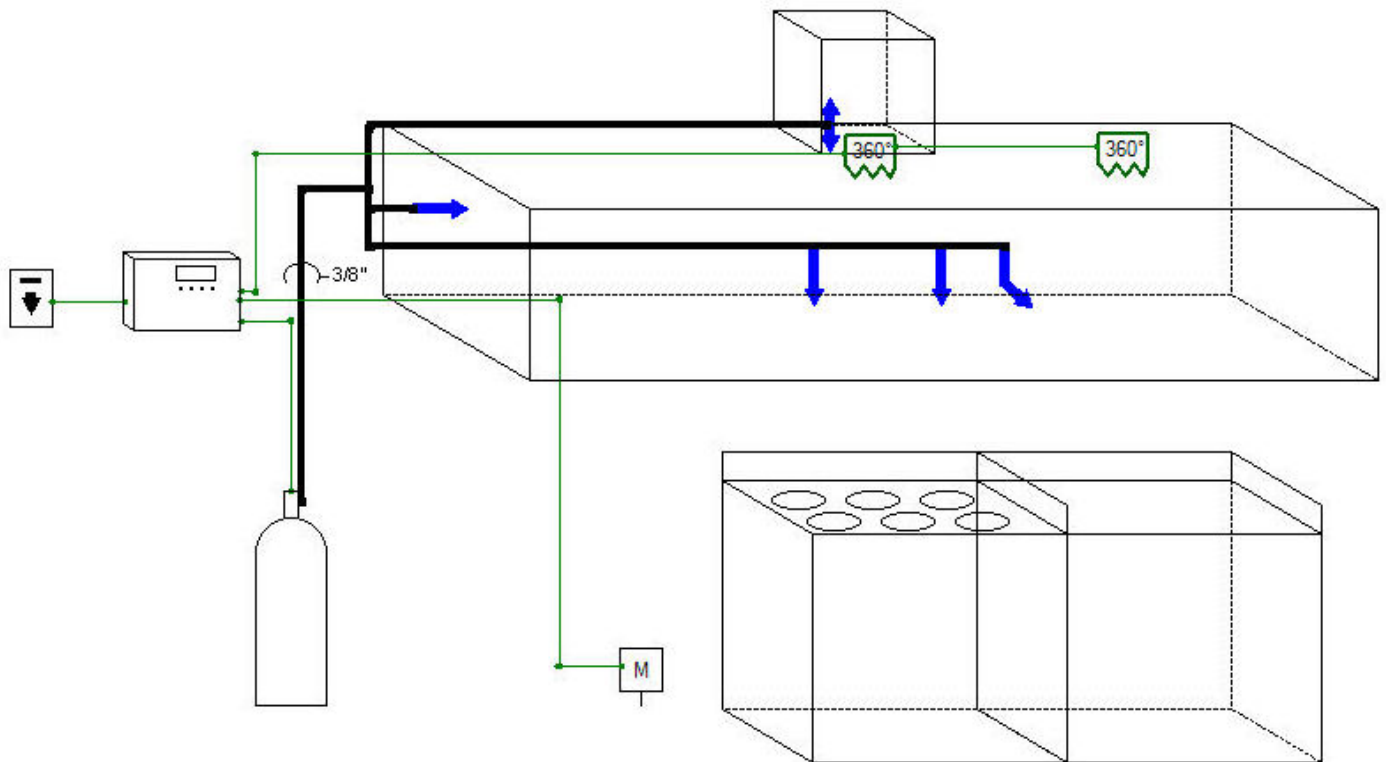
## 6. Piping the System



FlashPointsSuppressionCAD features a special set of tools for adding pipe to a drawing. Select the Piping tab on the Tool panel to switch the drawing to Piping mode. While in Piping mode appliances and protection apparatus cannot be moved or changed. This allows you to work with piping without worrying about changing other elements of the drawing.

The Piping screen has two modes, drawing mode and tool mode. As the names imply, drawing mode is for drawing pipe and tool mode is for moving, labeling and removing pipe. Use the tool selection button   to choose the desired mode. This button acts as a toggle between the two modes. When in tool mode the pencil will be colored to indicate that clicking the button will change to draw mode. When in draw mode the wrench will be colored to indicate that clicking the button will change to tool mode. The cursor tool tip also indicates what mode will be enabled when the button is clicked.

When the mouse cursor is over the drawing canvas, it will look like a cross-hairs when in drawing mode. In tool mode the cursor will change to a pipe wrench. Moving the cursor off of the drawing canvas will change the cursor back to an arrow to make it easier to interact with the buttons of the Tool panel and the FlashPoints menus.

When the Piping tab is clicked to enter the Piping screen, FlashPointsSuppressionCAD sets the mode to drawing mode. The cursor changes to cross-hairs to make it easier to locate the ends of each pipe segment.

Before drawing any pipe, 3 settings should be checked to make sure the pipe will appear as desired. The Pipe sample at the top of the Tool panel shows how the pipe will appear when drawn. The three settings that can be changed are: the pipe thickness, the end caps of the pipe, and the pipe color.

There are 9 pipe thicknesses available in FlashPoints. To change the pipe thickness click the up and down arrows next to the number to the right of the pipe sample. Each time a change is made it will be instantly reflected on the pipe sample. With a little practice you will quickly find which pipe settings work the best for your needs. Flash-Soft recommends using a pipe thickness of 4 for piping and a setting of 1 for detection lines.

The end caps of the pipe can be changed to represent pipe fittings (for pipe) and corner pulleys (for detection lines). Pipe fittings are represented by square end caps and corner pulleys are represented by round end caps.

Pipe and detection lines can be BLACK (the default color) or changed to a different color to make them easier to follow. Press the Color Selection button  to bring up a palette of 30 colors to choose from.



Each time any of these settings are changed the effect is applied to the next pipe segment drawn. This means that a wide variety of piping can be added to any drawing.

The last tool available on the Tool panel is the PIPE CLEAR button . Pressing this button will erase all pipe and detection lines from the drawing. This is useful if it becomes necessary to clear all of the pipe and start drawing the piping over again. It is much easier to clear all of the pipes than to click on each pipe and remove them one at a time.

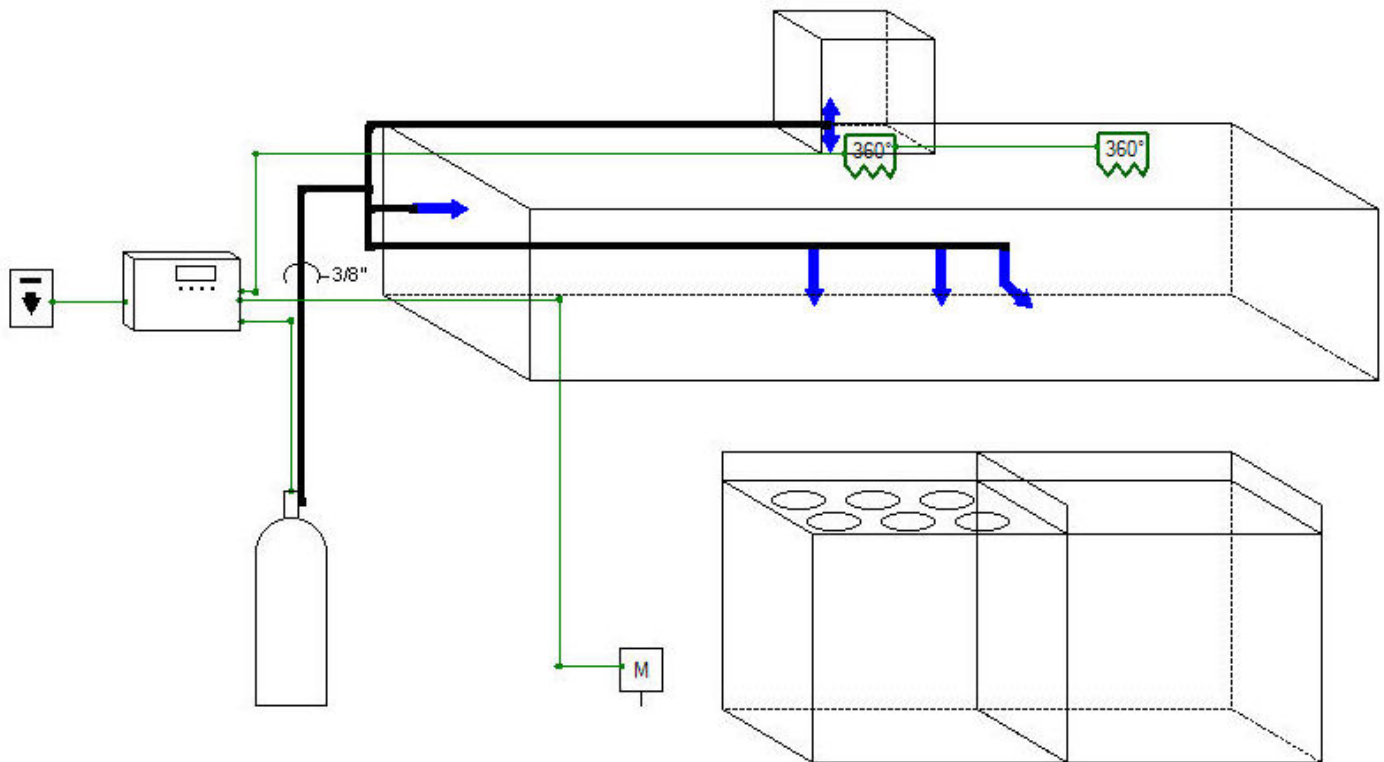
## 6. Piping the System



FlashPointsSuppressionCAD features a special set of tools for adding pipe to a drawing. Select the Piping tab on the Tool panel to switch the drawing to Piping mode. While in Piping mode appliances and protection apparatus cannot be moved or changed. This allows you to work with piping without worrying about changing other elements of the drawing.

The Piping screen has two modes, drawing mode and tool mode. As the names imply, drawing mode is for drawing pipe and tool mode is for moving, labeling and removing pipe. Use the tool selection button   to choose the desired mode. This button acts as a toggle between the two modes. When in tool mode the pencil will be colored to indicate that clicking the button will change to draw mode. When in draw mode the wrench will be colored to indicate that clicking the button will change to tool mode. The cursor tool tip also indicates what mode will be enabled when the button is clicked.

When the mouse cursor is over the drawing canvas, it will look like a cross-hairs when in drawing mode. In tool mode the cursor will change to a pipe wrench. Moving the cursor off of the drawing canvas will change the cursor back to an arrow to make it easier to interact with the buttons of the Tool panel and the FlashPoints menus.

When the Piping tab is clicked to enter the Piping screen, FlashPointsSuppressionCAD sets the mode to drawing mode. The cursor changes to cross-hairs to make it easier to locate the ends of each pipe segment.

Before drawing any pipe, 3 settings should be checked to make sure the pipe will appear as desired. The Pipe sample at the top of the Tool panel shows how the pipe will appear when drawn. The three settings that can be changed are: the pipe thickness, the end caps of the pipe, and the pipe color.

There are 9 pipe thicknesses available in FlashPoints. To change the pipe thickness click the up and down arrows next to the number to the right of the pipe sample. Each time a change is made it will be instantly reflected on the pipe sample. With a little practice you will quickly find which pipe settings work the best for your needs. Flash-Soft recommends using a pipe thickness of 4 for piping and a setting of 1 for detection lines.

The end caps of the pipe can be changed to represent pipe fittings (for pipe) and corner pulleys (for detection lines). Pipe fittings are represented by square end caps and corner pulleys are represented by round end caps.

Pipe and detection lines can be BLACK (the default color) or changed to a different color to make them easier to follow. Press the Color Selection button  to bring up a palette of 30 colors to choose from.

Each time any of these settings are changed the effect is applied to the next pipe segment drawn. This means that a wide variety of piping can be added to any drawing.

The last tool available on the Tool panel is the PIPE CLEAR button . Pressing this button will erase all pipe and

## 6.1. Drawing Pipe

In drawing mode, pipe is drawn by clicking at each end of the pipe segment. To start drawing pipe, position the cross-hairs where you want the pipe segment to begin. Use the center of the cross-hairs to position where the pipe will begin. Click the mouse button to mark the start of the pipe. A small red circle will appear on the drawing to indicate the starting point. Move the cross-hairs (mouse) and click to draw the pipe.

Piping can be drawn in three directions: diagonally, horizontally and vertically.

**Horizontal and Vertical Pipe:** FlashPoints measures the distance that the mouse is moved away from the starting point to determine which direction the pipe will be drawn. Pipe will always be drawn in a straight line, in the longest direction that the mouse is moved from the starting point.

**Diagonal Pipe:** To draw diagonal pipe, begin as you would any other pipe; click once at the starting location to place a small red circle on the drawing. To complete the pipe segment, move the mouse to the location of the other end of the pipe, hold down the Control (CTRL) Key, and click the mouse again. The pipe will be drawn as a straight line between the two points.

To cancel pipe drawing, after the starting point has been marked with a red circle, RIGHT-CLICK the mouse. This will remove the red circle and cancel the line drawing.

Pipe drawing tools are available to draw pipe (with pipe fittings on the ends), detection lines (with corner pulleys), arrows (for annotating), and broken pipe to indicate very long runs of pipe or detection lines.

## 6.2. Using the Pipe Tool

When the cursor looks like a pipe wrench the program is in tool mode. Click on a segment of pipe to work with that section of pipe. The pipe section will turn red to indicate that it has been selected. Mousing over a selected pipe segment will make the Minibar appear above the pipe. The Pipe Minibar has 4 buttons: one to move the pipe label (when visible) to the opposite side of the pipe, one to turn the pipe label on or off, one to change or enter the pipe label, and one to erase the selected pipe segment.

Diagonal pipe minibar only have one button, the erase button. Labels are not available for diagonal pipe. Press the A button to type a label for the pipe segment. Pipe labels are automatically positioned at the middle of the pipe segment. Labels can be moved from one side of the pipe to the other by pressing the arrow button on the MiniBar. Each time the label moves, the arrow button changes to point in the opposite direction to indicate where the label can be moved to if the button is pressed again. Please note that pipe labels are limited to the number of characters that can comfortably fit along the length of the pipe segment. Labels are not available for diagonal pipe.

Toggle pipe labels off and on by pressing the T button on the [Minibar](#)

Labels can be moved along the pipe by positioning the pipe wrench (mouse pointer) at the position that the label is to be moved to and RIGHT-CLICKing the mouse. The label will instantly move to the new location.

To move a pipe segment, click on a red pipe segment and drag it to its new location. Alternatively selected pipe can be moved with the arrow keys on the keyboard.

As with other FlashPoint objects, press the X button on the [Minibar](#) to remove the selected pipe segment from the drawing.

Clicking on a selected pipe will unselect it and return it to its original color.

To bend a segment of pipe, click the CURVE icon on the Minibar. A blue square will appear in the middle of the pipe. Click and drag the blue square to another location, then release the mouse button. FlashPoint will redraw the pipe segment with a bend at the location of the blue square. When the pipe is unselected the blue square will be removed.

The MODIFY PIPE icon on the Minibar brings up a window that will allow changes to be made to the pipe thickness, the type of pipe, and the pipe color.

## 6.3. Piping Tips

As you use the FlashPoints piping tools you will discover the easiest ways to add pipe to your drawings. The tips below are provided to give you a jumpstart.

1. Start laying pipe by connecting nozzles. Begin with the nozzle farthest from the cylinder and work toward the cylinder.
2. Don't worry about trying to click at the exact position where a pipe segment will end. Just try to click at the length that you want the pipe segment to be. FlashPoints will automatically draw a straight piece of pipe, unless the control key has been pressed to draw a diagonal pipe segment.
3. FlashPoints does not always place nozzles in a straight line. It is easiest to draw a pipe segment along a series of nozzles, then switch to the drawing canvas [by CLICKing the Canvas Items tab on the Tool panel] and moving the nozzle so they are lined up along the pipe.
4. Pipe segments cannot be resized. If a segment does not work out, erase it using the Minibar.
5. Choose the correct type of pipe so you can be sure the drawing will work with the Pipe Diagram option later.
  - Pipe connected to cylinders and nozzles should use Pipe Fittings.
  - Detection Lines should use Corner Pulleys.
  - Use the plain Line for Actuation tubing and roof lines.

**PRO-TIP:** Clicking the RIGHT mouse button will toggle between the drawing tool and the monkey wrench.



## 6.4. Pipe Calculator

Enter pipe lengths, number of fittings, and nozzle flow points on the Pipe Calculator and let FlashPoints compute the pipe equivalent lengths and volumes for you.

Each cylinder in the system will be pictured in the Pipe Calculator. Scroll to the desired cylinder and enter the values in the white text boxes. After entering each value, press ENTER, TAB, or click the next box to instantly compute the equivalent length and volume. All values are automatically saved to the FlashPoints database.

To indicate that a cylinder is manifolded with another cylinder, select the "manifoldmate" in the dropdown list. The cylinder will be marked as "MANIFOLDED" and the flow points of the "manifoldmate" will be updated to include the flow points of the selected cylinder and a miniature representation of the manifolded cylinder will appear beside the "manifoldmate".

Cylinders that are added or removed from the drawing are automatically added/removed from the Pipe Calculator.

The Pipe Calculator uses the number system of the job to determine the values entered and shown. Imperial (US) values are in feet, inches, and cubic inches; Metric values are in meters, centimeters, and cubic centimeters. A button in the upper right corner can be used to switch entry between feet and inches, or meters and centimeters.

Values entered into the Pipe Calculator can be printed as a CYLINDER PIPING CHART in the B or C areas of the Printing Templates.

## **7. Completing the System [Fire Equipment Dealer Version Only]**

Now that the drawing is complete and the job information and notes have been entered, it is time to enter the materials and costs of the job. This next step will use information from the FlashPoints Suppression CAD drawing to assist with building a bill of materials and help you compute the cost of the job.

## 7.1. Specifying Materials [Fire Equipment Dealer Version Only]

The screenshot shows the 'Requirements' screen in the FlashPoint software. The interface includes a menu bar at the top, a toolbar on the left, and a main grid for listing materials. A 'Required Flow Value' gauge is located on the left side of the grid. The table below represents the data shown in the grid:

| Item Number | Description  | Source     | Type     | Flowpoints | Quantity | Price  | Total   |
|-------------|--|------------|----------|------------|----------|--------|---------|
| 13729       | Nozzle - Fryer, Griddle  | ON DRAWING | NOZZLE   | 4.00       | 2.00     | 29.00  | 58.00   |
| 11982       | Nozzle - Appliances, Plenum  | ON DRAWING | NOZZLE   | 6.00       | 6.00     | 29.00  | 174.00  |
| 14178       | Nozzle - 2D Appliances and Four Burner Range/48" Griddle                               | ON DRAWING | NOZZLE   | 4.00       | 2.00     | 29.00  | 58.00   |
| 16416       | Nozzle - Duct  | ON DRAWING | NOZZLE   | 4.00       | 4.00     | 29.00  | 116.00  |
| 21481       | Manual Pull Station (Recess or Surface Mount)  | ON DRAWING | PULL     |            | 1.00     | 105.00 | 105.00  |
| 18000       | MRM II with Rod Enclosure  | ON DRAWING | CTLBOX   |            | 1.00     | 354.00 | 354.00  |
| 13334       | Model 3.75 Agent Cylinder, w/Discharge Valve, Filled & Charged                         | ON DRAWING | CYLINDER | 22.00      | 2.00     | 640.00 | 1280.00 |
| 12328       | Fusible Link - 360 Degrees F. ("K")  | ON DRAWING | FLINK    |            | 6.00     | 6.70   | 40.20   |
| 12790       | Amerex Brass Gas Valve - Mech - 3/4 inch   | ON DRAWING | GASVALVE |            | 1.00     | 368.00 | 368.00  |
| 10199       | Discharge Adapter Kit 3/4 NPT - Agent Cylinder 6.14 gal.                               |            | DISADAPT |            |          |        | 32.00   |
| 16920       | Bracket Asy, Agent Cylinder 2.75, 3.75 & 4.75 gal. (w/Swivel Adapter)                  |            | BRACKET  |            |          |        | 86.00   |
| 16985       | Bracket Asy, Agent Cylinder 3.75 gal. (w/Dist. Hose As'y and Dist. Outlet)             |            | BRACKET  |            |          |        | 91.00   |
| 17690       | Bracket Asy, Agent Cylinder 3.75 gal. (w/Swivel Adapter)                               |            | BRACKET  |            |          |        | 86.00   |
| 21983       | Bracket (Discontinued)   |            | BRACKET  |            |          |        |         |
| 23184       | Bracket Asy, Agent Cylinder 6.14 gal.  |            | BRACKET  |            |          |        | 112.00  |
| 10147       | Pneumatic Actuator - Agent Cylinder 6.14.  |            | CTLBOXEQ |            |          |        | 170.00  |
| 17484       | Low Pressure Module - Optional   |            | CTLBOXEQ |            |          |        | 180.00  |
| 12508       | Detector (Includes Bracket, Linkage and Conduit Fittings)                              |            | MISC     |            |          |        | 18.00   |
| 16557       | Detection Tubing 25 ft.  |            | MISC     |            |          |        | 185.00  |
| 16551       | Detection Tubing 50 ft.  |            | MISC     |            |          |        | 360.00  |
| 16579       | Detection Tubing 100 ft.   |            | MISC     |            |          |        | 700.40  |
| 16552       | Detection Tubing 150 ft.   |            | MISC     |            |          |        | 1000.00 |
| 16554       | Detection Tubing 300 ft.   |            | MISC     |            |          |        | 1950.00 |
| 17515       | Termination Kit - Link Detection - Includes beginning cable, end cable and conduit box |            | MISC     |            |          |        | 49.50   |
| 17354       | Cable Segment 24" - Link-to-link   |            | MISC     |            |          |        | 11.00   |
| 19155       | Cable Segment 12" - Link-to-link   |            | MISC     |            |          |        | 11.00   |
| 17520       | Eyebolt Support  |            | MISC     |            |          |        | 6.50    |
| 11978       | Cabinet, Stainless Steel (will hold 1 KP375 Agent Cylinder & MRM)                      |            | MISC     |            |          |        | 550.00  |
| 16814       | Enclosure, Stainless Steel (will hold 1 KP275, KP375 or KP475 Agent Cylinder)          |            | MISC     |            |          |        | 498.00  |
| 16901       | Swivel Adapter for 2.75 or 3.75 Agent Cylinder   |            | MISC     |            |          |        | 32.00   |
| 12854       | Actuation Hose - (N2 - 1/4" x 16')   |            | MISC     |            |          |        | 28.00   |
| 16448       | Actuation Hose - (N2 - 1/4" x 32')   |            | MISC     |            |          |        | 56.00   |
| 12856       | Nitrogen Cylinder - 10 in(3)   |            | MISC     |            |          |        | 175.00  |
| 10173       | Vent Check (Required on Actuation Line)  |            | MISC     |            |          |        | 60.00   |
| 12308       | Corner Pulley  |            | MISC     |            |          |        | 13.00   |
| 16444       | Corner Pulley - CPS Brooks Style   |            | MISC     |            |          |        | 9.20    |
| 12553       | Cable, 1/16" (per foot)  |            | MISC     |            |          |        | 0.30    |
| 12506       | Pulley Tee   |            | MISC     |            |          |        | 146.00  |
| 12507       | Conduit Offset   |            | MISC     |            |          |        | 15.50   |

Materials: 2553.20 Mtg Discount: 1276.60 Net Materials: 1276.60

Clicking the Requirementstab above the drawingcanvas will display the Requirementsscreen. A grid-like box and text boxes make up this screen. Protection apparatus from the drawing appears in blue at the top of the grid. The can only be changed by changing the drawing.

The remainder of the grid is the Additional Items section. Here you can select items from the manufacturer's catalog to your job, double-click the quantity box next to the desired item. Then type the quantity of that item. Pressing **EN** another box will save your entry and compute the cost of that item. If it is necessary to change a quantity, double click box and enter a new value. Entering a zero (0) in a box will remove that item from your inventory.

The cylinder-gauge, displayed on the Tool panel on the left side of the screen, is provided as a reminder of the system requirements. The flow values of the nozzles on the drawings are used by FlashPoint to determine if enough cylinders are selected. Each time you enter a quantity next to a cylinder item in the part list, FlashPoint will fill the picture of a cylinder with the total flow value of the chosen cylinders. Until the cylinder is full, it will fill with BLUE liquid. When the cylinder is filled, its color will change to RED to indicate that sufficient cylinders have been selected. The flow value displayed is the actual flow value of the chosen cylinders. This is helpful for ensuring that a system is designed for expansion, if desired.

If items, such as cylinders or gas valves, were placed on the drawing canvas, they will not be available for selection on the requirements screen. Likewise, items that are selected on the requirements page will cause the corresponding button on the Tool panel to be disabled. This is to help prevent unwanted duplication of protection items. The basic rule of thumb is to select protection items on the drawing canvas if they are to appear on the drawing, otherwise select them from the Requirements screen to include them in the job costs without showing them on the drawing.

To assist with item selection, FlashPoint places a star ★ next to items that are required system components. This is to draw your attention to certain items in the list. For example, all of the cylinders will have a star next to them, because they are required components of the job. There is no need to choose all of the cylinders. Just choose what is needed for the job.

The third section on the Requirementsscreen is for entering costs and discounts. There are two kinds of values that



## 7.2. Costing the Job [Fire Equipment Dealer Version Only]

Design Canvas | Job Info | Requirements | System Specifications

Job Requirements

Prices are in US Dollar

== required system components

| Item Number | Description  | Source     | Type     | Flowpoints | Quantity | Price   | Total   |
|-------------|--|------------|----------|------------|----------|---------|---------|
| 13729       | Nozzle - Fryer, Griddle  | ON DRAWING | NOZZLE   | 4.00       | 2.00     | 29.00   | 58.00   |
| 11982       | Nozzle - Appliance, Plenum   | ON DRAWING | NOZZLE   | 6.00       | 6.00     | 29.00   | 174.00  |
| 14178       | Nozzle - ZD Appliances and Four Burner Range/48" Griddle                               | ON DRAWING | NOZZLE   | 4.00       | 2.00     | 29.00   | 58.00   |
| 16416       | Nozzle - Duct  | ON DRAWING | NOZZLE   | 4.00       | 4.00     | 29.00   | 116.00  |
| 21481       | Manual Pull Station (Recess or Surface Mount)  | ON DRAWING | PULL     |            | 1.00     | 105.00  | 105.00  |
| 18000       | MRM II with Red Enclosure  | ON DRAWING | CTLBOX   |            | 1.00     | 354.00  | 354.00  |
| 13334       | Model 3.75 Agent Cylinder, w/Discharge Valve, Filled & Charged                         | ON DRAWING | CYLINDER | 22.00      | 2.00     | 640.00  | 1280.00 |
| 12328       | Fusible Link - 360 Degrees F. ("K")  | ON DRAWING | FLINK    |            | 6.00     | 6.70    | 40.20   |
| 12790       | Amerex Brass Gas Valve - Mech - 3/4 inch   | ON DRAWING | GASVALVE |            | 1.00     | 368.00  | 368.00  |
| 10199       | Discharge Adapter Kit 3/4 NPT - Agent Cylinder 6.14 gal.                               |            | DISADAPT | +          |          | 32.00   |         |
| 16920       | Bracket As'y, Agent Cylinder 2.75, 3.75 & 4.75 gal. (w/Swivel Adapter)                 |            | BRACKET  | +          |          | 86.00   |         |
| 16085       | Bracket As'y, Agent Cylinder 3.75 gal. (w/Dist. Hose As'y and Dist. Outlet)            |            | BRACKET  | +          |          | 91.00   |         |
| 17690       | Bracket As'y, Agent Cylinder 3.75 gal. (w/Swivel Adapter)                              |            | BRACKET  | +          |          | 86.00   |         |
| 21583       | Bracket (Discontinued)   |            | BRACKET  | +          |          |         |         |
| 23184       | Bracket As'y, Agent Cylinder 6.14 gal.   |            | BRACKET  | +          |          | 112.00  |         |
| 10147       | Pneumatic Actuator - Agent Cylinder 6.14.  |            | CTLBOXEQ |            |          | 170.00  |         |
| 17484       | Low Pressure Module - Optional   |            | CTLBOXEQ |            |          | 180.00  |         |
| 12508       | Detector (Includes Bracket, Linkage and Conduit Fittings)                              |            | MISC     |            |          | 18.00   |         |
| 16557       | Detection Tubing 25 ft   |            | MISC     |            |          | 185.00  |         |
| 16551       | Detection Tubing 50 ft   |            | MISC     |            |          | 360.00  |         |
| 16579       | Detection Tubing 100 ft.   |            | MISC     |            |          | 700.40  |         |
| 16552       | Detection Tubing 150 ft.   |            | MISC     |            |          | 1000.00 |         |
| 16554       | Detection Tubing 300 ft.   |            | MISC     |            |          | 1950.00 |         |
| 17515       | Termination Kit - Link Detection - Includes beginning cable, end cable and conduit box |            | MISC     |            |          | 49.50   |         |
| 17354       | Cable Segment 24" - Link-to-link   |            | MISC     |            |          | 11.00   |         |
| 19155       | Cable Segment 12" - Link-to-link   |            | MISC     |            |          | 11.00   |         |
| 17520       | Eyebolt Support  |            | MISC     |            |          | 6.50    |         |
| 11978       | Cabinet, Stainless Steel (will hold 1 KP375 Agent Cylinder & MRM)                      |            | MISC     |            |          | 550.00  |         |
| 16814       | Enclosure, Stainless Steel (will hold 1 KP275, KP375 or KP475 Agent Cylinder)          |            | MISC     |            |          | 498.00  |         |
| 16901       | Swivel Adapter for 2.75 or 3.75 Agent Cylinder   |            | MISC     |            |          | 32.00   |         |
| 12854       | Actuation Hose - (N2 - 1/4" x 16")   |            | MISC     |            |          | 28.00   |         |
| 16448       | Actuation Hose - (N2 - 1/4" x 32")   |            | MISC     |            |          | 56.00   |         |
| 12856       | Nitrogen Cylinder - 10 in(3)   |            | MISC     |            |          | 175.00  |         |
| 10173       | Vent Check (Required on Actuation Line)  |            | MISC     |            |          | 60.00   |         |
| 12309       | Corner Pulley  |            | MISC     |            |          | 13.00   |         |
| 16444       | Corner Pulley - CP5 Brooks Style   |            | MISC     |            |          | 9.20    |         |
| 12553       | Cable, 1/16" (per foot)  |            | MISC     |            |          | 0.30    |         |
| 12506       | Pulley Tee   |            | MISC     |            |          | 146.00  |         |
| 12507       | Conduit Offset   |            | MISC     |            |          | 15.50   |         |

Materials: 2553.20 Mfg Discount: 1276.60 Net Materials: 1276.60

As the costs of materials, labor, fees, and discounts are added to the Requirements screen, FlashPoints suppresses the job. The job cost is shown in the lower right corner of the Requirements screen. By updating this value each time FlashPoints gives you the ability to make adjustments to the job in real time.

The Requirements screen is made up of 3 parts: The product list, other costs, and sales tax and totals.

The Product List is a table of system parts and their list prices. Systems parts that are added to the drawing are at the top of the list. Other items may be selected by clicking in the Quantity column and entering the required quantity of that displayed in the Total column.

The prices in the Product List are manufacturer list prices that are updated by Flash-Soft. If a price is not available, for the item and type a new price, then press ENTER. The new price will be saved in the FlashPoints database and that the price has been overridden, a green square will appear in the column to the right of the price column. To remove price, blank out the price and press ENTER. FlashPoints will bring back the list price.

Costs and Fees are entered in the upper right corner of the Requirements screen. Enter the cost of each item and then to take. After all costs are entered, enter the Margin Percentage that you hope to make on the job. Knowing your profit give you an advantage while negotiating the price of the job with the client.



Sales Tax and Totals for the job are displayed in the lower left corner of the Requirements screen. The final total at customer.



## 7.3. Submittal Pages

Select the system parts to be included in your submittal package:

### Selected Items

| CYLINDER   | NOZZLE    |           |           |        |           |          |          |      |         |             |           |          |          |          |         |              |   |   |   |                 |          |                   |       |                          |       |                    |       |               |       |                  |       |      |       |                   |       |
|--|-----------|-----------|-----------|--------|-----------|----------|----------|------|---------|-------------|-----------|----------|----------|----------|---------|--------------|---|---|---|-----------------|----------|-------------------|-------|--------------------------|-------|--------------------|-------|---------------|-------|------------------|-------|------|-------|-------------------|-------|
| <div style="display: flex; align-items: center;"> <input checked="" type="checkbox"/> <div style="margin-left: 10px;"> <h3>Agent Cylinder - 2.75 gallon</h3> </div> </div> <div style="text-align: center; margin-top: 10px;">  <p><b>AGENT CYLINDER - KP275</b></p> </div> <table border="1" style="margin-top: 10px; width: 100%;"> <thead> <tr> <th>Model 275</th> <th>U.S.</th> <th>SI Metric</th> </tr> </thead> <tbody> <tr> <td>Weight</td> <td>22.00 lbs</td> <td>10.00 kg</td> </tr> <tr> <td>Capacity</td> <td>5.00</td> <td>22.00 L</td> </tr> <tr> <td>Weight Full</td> <td>25.50 lbs</td> <td>25.00 kg</td> </tr> <tr> <td>Capacity</td> <td>2.75 gal</td> <td>10.41 L</td> </tr> <tr> <td>Other Models</td> <td>0</td> <td>0</td> </tr> </tbody> </table> <p style="font-size: small; margin-top: 5px;"> <b>P/N: 16921</b><br/>                     Assembly of Model 275 Agent Cylinder Assemblies from 2.75 gallon agent capacity and an liquid bottle that only contains KP that Chemical Agent. The cylinders are provided with the stopper or cap for a purpose of full and emptying of the (2) 275. This set in the standard one which challenges the one chemical agent through the distributor network. Our cylinder is capable of supplying agent for 90 seconds.                 </p> | Model 275 | U.S.      | SI Metric | Weight | 22.00 lbs | 10.00 kg | Capacity | 5.00 | 22.00 L | Weight Full | 25.50 lbs | 25.00 kg | Capacity | 2.75 gal | 10.41 L | Other Models | 0 | 0 | <div style="display: flex; align-items: center;"> <input checked="" type="checkbox"/> <div style="margin-left: 10px;"> <h3>Nozzles</h3> </div> </div> <div style="text-align: center; margin-top: 10px;">  <p><b>KP DISK</b></p> </div> <table border="1" style="margin-top: 10px; width: 100%; font-size: x-small;"> <thead> <tr> <th>APPLICABLE TYPE</th> <th>PART NO.</th> </tr> </thead> <tbody> <tr> <td>Agencies &amp; Retail</td> <td>11262</td> </tr> <tr> <td>Small Fire Class Station</td> <td>11263</td> </tr> <tr> <td>Large Fire Station</td> <td>11264</td> </tr> <tr> <td>Open &amp; Closed</td> <td>11265</td> </tr> <tr> <td>Range (3 Burner)</td> <td>11266</td> </tr> <tr> <td>Deck</td> <td>11267</td> </tr> <tr> <td>Deck Staff Access</td> <td>11268</td> </tr> </tbody> </table> <p style="font-size: x-small; margin-top: 5px;">                     The KAMERICA KP system uses 2 different size to identify the tank and size of canister with high temperature inside cap.                 </p> | APPLICABLE TYPE | PART NO. | Agencies & Retail | 11262 | Small Fire Class Station | 11263 | Large Fire Station | 11264 | Open & Closed | 11265 | Range (3 Burner) | 11266 | Deck | 11267 | Deck Staff Access | 11268 |
| Model 275  | U.S.      | SI Metric |           |        |           |          |          |      |         |             |           |          |          |          |         |              |   |   |   |                 |          |                   |       |                          |       |                    |       |               |       |                  |       |      |       |                   |       |
| Weight   | 22.00 lbs | 10.00 kg  |           |        |           |          |          |      |         |             |           |          |          |          |         |              |   |   |   |                 |          |                   |       |                          |       |                    |       |               |       |                  |       |      |       |                   |       |
| Capacity   | 5.00      | 22.00 L   |           |        |           |          |          |      |         |             |           |          |          |          |         |              |   |   |   |                 |          |                   |       |                          |       |                    |       |               |       |                  |       |      |       |                   |       |
| Weight Full  | 25.50 lbs | 25.00 kg  |           |        |           |          |          |      |         |             |           |          |          |          |         |              |   |   |   |                 |          |                   |       |                          |       |                    |       |               |       |                  |       |      |       |                   |       |
| Capacity   | 2.75 gal  | 10.41 L   |           |        |           |          |          |      |         |             |           |          |          |          |         |              |   |   |   |                 |          |                   |       |                          |       |                    |       |               |       |                  |       |      |       |                   |       |
| Other Models   | 0         | 0         |           |        |           |          |          |      |         |             |           |          |          |          |         |              |   |   |   |                 |          |                   |       |                          |       |                    |       |               |       |                  |       |      |       |                   |       |
| APPLICABLE TYPE  | PART NO.  |           |           |        |           |          |          |      |         |             |           |          |          |          |         |              |   |   |   |                 |          |                   |       |                          |       |                    |       |               |       |                  |       |      |       |                   |       |
| Agencies & Retail  | 11262     |           |           |        |           |          |          |      |         |             |           |          |          |          |         |              |   |   |   |                 |          |                   |       |                          |       |                    |       |               |       |                  |       |      |       |                   |       |
| Small Fire Class Station   | 11263     |           |           |        |           |          |          |      |         |             |           |          |          |          |         |              |   |   |   |                 |          |                   |       |                          |       |                    |       |               |       |                  |       |      |       |                   |       |
| Large Fire Station   | 11264     |           |           |        |           |          |          |      |         |             |           |          |          |          |         |              |   |   |   |                 |          |                   |       |                          |       |                    |       |               |       |                  |       |      |       |                   |       |
| Open & Closed  | 11265     |           |           |        |           |          |          |      |         |             |           |          |          |          |         |              |   |   |   |                 |          |                   |       |                          |       |                    |       |               |       |                  |       |      |       |                   |       |
| Range (3 Burner)   | 11266     |           |           |        |           |          |          |      |         |             |           |          |          |          |         |              |   |   |   |                 |          |                   |       |                          |       |                    |       |               |       |                  |       |      |       |                   |       |
| Deck   | 11267     |           |           |        |           |          |          |      |         |             |           |          |          |          |         |              |   |   |   |                 |          |                   |       |                          |       |                    |       |               |       |                  |       |      |       |                   |       |
| Deck Staff Access  | 11268     |           |           |        |           |          |          |      |         |             |           |          |          |          |         |              |   |   |   |                 |          |                   |       |                          |       |                    |       |               |       |                  |       |      |       |                   |       |

### Unselected Items

SubmittalPages are typically pages of information and specification data that is supplied by the manufacturer of the system and drawing notes to make up a SubmittalPackage.

FlashPoints contains some submittal pages that can be used right away. In fact, the submittal pages that come with so FlashPoints can automatically select them. The black square to the left of each submittal item is a checkbox. When the box is white, it is unselected. Check or uncheck items to add or remove them from the submittal package.

There are 3 buttons in the upper right corner of the screen that are used to manage a submittal package. From left to right: RESET button.

The GROUP/UNGROUP button is used to remove the SELECTED ITEMS/UNSELECTED ITEMS groups and selected without stopping to sort and regroup them after each selection. The ADD button is used to add submittal pages to the FlashPoints database.

### Warranty

### Liquid Agent Recharge

### Cylinder Bracket - 6

The Add Page Window has a button to Select a Picture. There are also 3 pieces of information that must be entered: Manufacturer, Item Category, and Description. The first 2 have drop down boxes with a list of items that can be selected. For Manufacturer, the options are the current manufacturer or ALL. Selecting ALL will make the page available to every job you create. The Description can be anything that describes the page. It is recommended to keep this brief.

Once a new page has been added it will look like the first item in the picture on the right. A gold star will be displayed in the upper right corner to identify it as a user added page. An edit button will be displayed in the lower right corner. The edit button is used to change the picture or information saved with the page. The edit button can also be used to remove the page from FlashPoints.

Submittal pages added to FlashPoints are stored in one of FlashPoints' databases. They are

## 8. Printing Reports

FlashPoints reports are selected from the print menu (FILE | PRINT). The Job Design Plan is only available when the Design Canvas is visible on the screen. At all other times the Job Design Plan option is grayed out on the menu. The reason for this is to prevent a report from being printed without the drawing on the screen. When the drawing is printed, FlashPoints Suppression CAD takes a snapshot of the drawing canvas and sends the snapshot to the printer.

The Job Design Plan is the report that prints the drawing, design notes, and a list of job materials. This report is also known as the Fire Marshall report, because most Fire Marshall's require a system design plan prior to installation. [To ensure that a drawing is visible on the screen, FlashPoints requires that the DESIGN CANVAS tab be clicked before the Job Design Report can be printed.]

The Job Cost Report [Fire Equipment Dealer Version Only] is a Bill of Materials for the job. Materials, costs and discounts for the job are itemized on this report.

When a report is printed, it is first displayed on the screen as a print preview. The print preview is useful for saving paper or reviewing the output in the field where a printer might not be available. Clicking the printer icon on the print preview will open the printer setup display. This display allows the selection of a specific printer and other printer functions (such as specifying the number of copies). When the Print button is clicked on the printer setup screen the report will be sent to the printer.

FlashPlan Credits are required to print FlashPoints drawings. Prints require 1 credit. Once a job has been printed, it may be edited and reprinted within a specified time period (the remaining time is displayed in the Status Area of the Main Screen). However, if the customer name or job description are changed the remaining free time will be cleared and the next print will require a credit.

Additional FlashPlan Credits are available from FlashPoints in lots of 10, 30, and 50 Credits.



# 8.1. Enhanced Printing

FlashPoints Printing Templates

## FlashPoints Drawing Setup

1 credit

1. Orientation:  Landscape  Portrait

2. Choose Page Template:

Print Divider Lines  
 Print Flow Point Totals  
 Print Stamp Box

A  B  C  
 D  E  F

3. Select Jobs / Images to Print:

**A**  
Canvas Drawing  
 Print Scale

**B**  
Material List

**C**  
Notes

CANCEL PRINT TO PDF PREVIEW PRINT PREVIEW

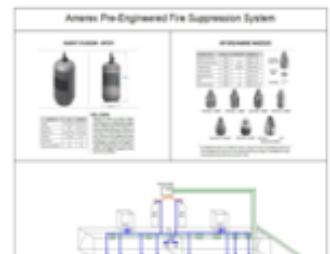
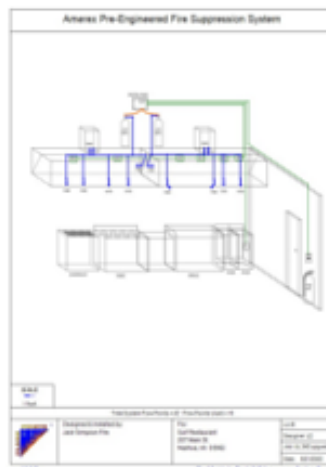
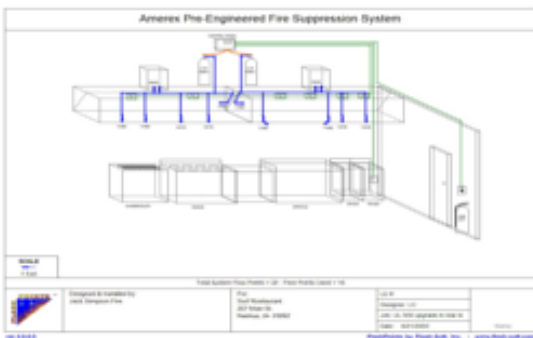



### 8.1.1. Pipe Diagram

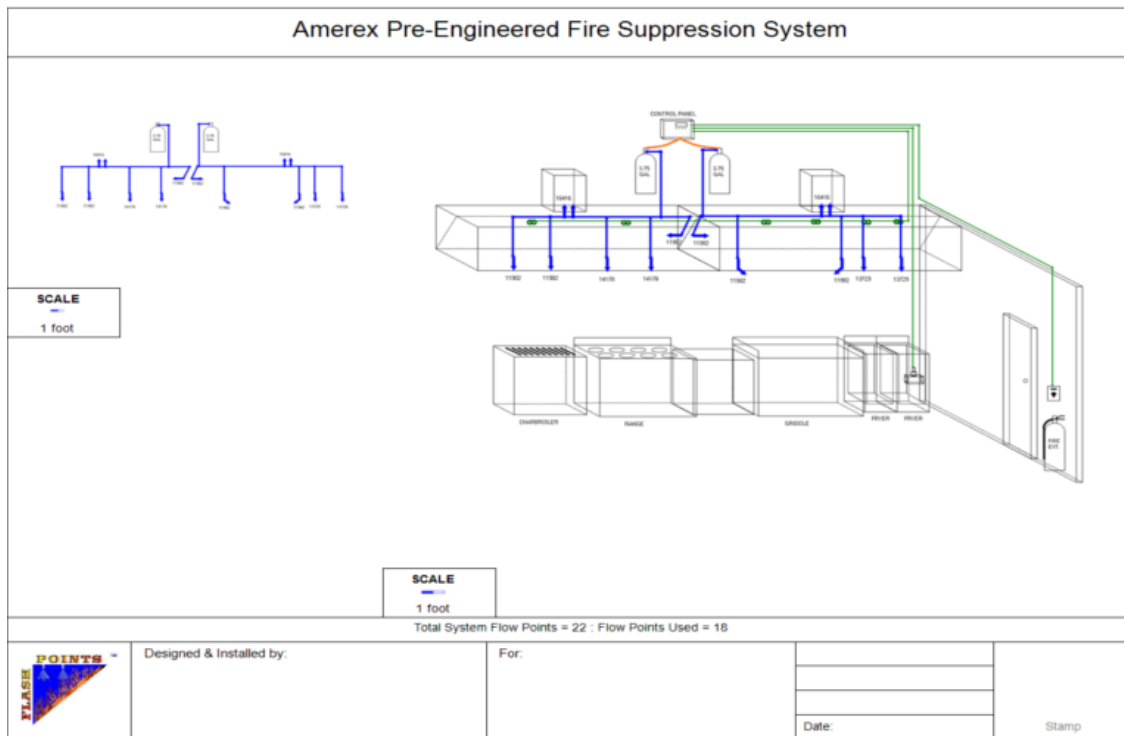

Pipe Diagrams present a view of the suppression system that contains the system cylinders, pipe, and nozzles. All appliances and other features of a drawing are removed to give a clear view of the system piping.

There is no need to make a separate drawing to add a pipe diagram. Simply choose the A-B or A-B-C template from the Printing Templates screen. Pipe Diagrams can be displayed in the B or C positions. Choose Pipe Diagram from the drop-down list for Image B or Image C and FlashPoints will do the rest.

### Select Jobs to Print:

Image A: 18 : UL 300 upgrade in rear kitchen

Image B: -- empty --  
 -- empty --  
 33 : Floor Plan  
 18 : UL 300 upgrade in rear kitchen  
 28 : test  
 Pipe Diagram  
 Other Image

### RECOMMENDATIONS FOR IMPROVED PIPE DIAGRAMS:

FlashPoints will use all pipe that has pipe fittings in pipe diagrams. Therefore, it is best to use pipe fittings for pipe, corner pulleys for detection lines, and plain lines or arrows for all other drawn lines. Broken pipe are also excluded from pipe diagrams.

Actuation lines, the copper tubing from the control head to the cylinders, should be drawn using the LINE. This will cause them to be excluded from pipe diagrams.

Nozzle and pipe labels are displayed on the pipe diagram exactly as they appear on the system drawing. It is best to label nozzles and pipe so the labels will appear on the pipe diagram.



## 8.2. Printing a Submittal Package

### Amerex Pre-Engineered Fire Suppression System

Total System Flow Points = 22, Flow Points Used = 18

|  |   |   |   |
|--|---|---|---|
|  | Designed & Installed by:<br>Jack Simpson Fire     | For:<br>Surf Restaurant<br>207 Main St.<br>Nashua, nh 03062 | LIC #:<br>Designer: LC<br>Job: UL300 Upgrade in rear kitchen<br>Date: 8/28/2020 |
|  | FlashPoint by FlashSoft, Inc. - www.flashsoft.com |   |   |

### Fire Suppression System Design Specifications

| Notes   |   | System Materials |             |          |       |                         |   |       |                              |   |       |   |   |       |              |   |       |   |   |       |                           |   |       |  |   |       |                                   |   |       |                                       |   |
|---|---|------------------|-------------|----------|-------|-------------------------|---|-------|------------------------------|---|-------|---|---|-------|--------------|---|-------|---|---|-------|---------------------------|---|-------|--|---|-------|-----------------------------------|---|-------|---------------------------------------|---|
| <ul style="list-style-type: none"> <li>- Fire Suppression System: Amerex Kitchen Protection UL300 as per attached specifications and drawings.</li> <li>- Provided Gas Valves are to be installed by the customer's Licensed Plumber.</li> <li>- Remote pull station shall be 48" above finished floor and in the path of egress.</li> <li>- All nozzles shall have brass caps.</li> <li>- Exhaust shall remain on during system discharge.</li> <li>- Upon activation an audible or visual indicator shall be provided.</li> <li>- Upon activation of system electrical &amp; fuel must shut down.</li> <li>- System shall have manual and automatic methods of activation.</li> <li>- A functional test shall be witnessed by the fire department inspector prior to cooking.</li> <li>- Installation of this Fire Suppression System shall comply with the latest edition of the Best Building Codes, NFPA 96 &amp; 17A, and I.M.C. Mechanical Codes.</li> </ul> | <table border="1" style="width: 100%; border-collapse: collapse;"> <thead> <tr> <th style="text-align: left;">Item Number</th> <th style="text-align: left;">Description</th> <th style="text-align: left;">Quantity</th> </tr> </thead> <tbody> <tr> <td>13729</td> <td>Nozzle - Foam - Griddle</td> <td>2</td> </tr> <tr> <td>11952</td> <td>Nozzle - Appliance, Pie Oven</td> <td>2</td> </tr> <tr> <td>14170</td> <td>Nozzle - 30" Appliances and Four Burner</td> <td>4</td> </tr> <tr> <td>18418</td> <td>Nozzle - 20"</td> <td>4</td> </tr> <tr> <td>21451</td> <td>Manual Pull Station - Recess or Surface</td> <td>1</td> </tr> <tr> <td>18000</td> <td>MRM in with Red Enclosure</td> <td>1</td> </tr> <tr> <td>13334</td> <td>Model 5175 Agent Cylinder w/ Discharge</td> <td>1</td> </tr> <tr> <td>13328</td> <td>Pull to Lock - 250 Degree F FIC 1</td> <td>1</td> </tr> <tr> <td>12790</td> <td>Amerex Brass Gas Valve - Mech - 24 in</td> <td>1</td> </tr> </tbody> </table> | Item Number      | Description | Quantity | 13729 | Nozzle - Foam - Griddle | 2 | 11952 | Nozzle - Appliance, Pie Oven | 2 | 14170 | Nozzle - 30" Appliances and Four Burner | 4 | 18418 | Nozzle - 20" | 4 | 21451 | Manual Pull Station - Recess or Surface | 1 | 18000 | MRM in with Red Enclosure | 1 | 13334 | Model 5175 Agent Cylinder w/ Discharge | 1 | 13328 | Pull to Lock - 250 Degree F FIC 1 | 1 | 12790 | Amerex Brass Gas Valve - Mech - 24 in | 1 |
| Item Number   | Description   | Quantity         |             |          |       |                         |   |       |                              |   |       |   |   |       |              |   |       |   |   |       |                           |   |       |  |   |       |                                   |   |       |                                       |   |
| 13729   | Nozzle - Foam - Griddle   | 2                |             |          |       |                         |   |       |                              |   |       |   |   |       |              |   |       |   |   |       |                           |   |       |  |   |       |                                   |   |       |                                       |   |
| 11952   | Nozzle - Appliance, Pie Oven  | 2                |             |          |       |                         |   |       |                              |   |       |   |   |       |              |   |       |   |   |       |                           |   |       |  |   |       |                                   |   |       |                                       |   |
| 14170   | Nozzle - 30" Appliances and Four Burner   | 4                |             |          |       |                         |   |       |                              |   |       |   |   |       |              |   |       |   |   |       |                           |   |       |  |   |       |                                   |   |       |                                       |   |
| 18418   | Nozzle - 20"  | 4                |             |          |       |                         |   |       |                              |   |       |   |   |       |              |   |       |   |   |       |                           |   |       |  |   |       |                                   |   |       |                                       |   |
| 21451   | Manual Pull Station - Recess or Surface   | 1                |             |          |       |                         |   |       |                              |   |       |   |   |       |              |   |       |   |   |       |                           |   |       |  |   |       |                                   |   |       |                                       |   |
| 18000   | MRM in with Red Enclosure   | 1                |             |          |       |                         |   |       |                              |   |       |   |   |       |              |   |       |   |   |       |                           |   |       |  |   |       |                                   |   |       |                                       |   |
| 13334   | Model 5175 Agent Cylinder w/ Discharge  | 1                |             |          |       |                         |   |       |                              |   |       |   |   |       |              |   |       |   |   |       |                           |   |       |  |   |       |                                   |   |       |                                       |   |
| 13328   | Pull to Lock - 250 Degree F FIC 1   | 1                |             |          |       |                         |   |       |                              |   |       |   |   |       |              |   |       |   |   |       |                           |   |       |  |   |       |                                   |   |       |                                       |   |
| 12790   | Amerex Brass Gas Valve - Mech - 24 in   | 1                |             |          |       |                         |   |       |                              |   |       |   |   |       |              |   |       |   |   |       |                           |   |       |  |   |       |                                   |   |       |                                       |   |

|  |   |   |   |
|--|---|---|---|
|  | Designed & Installed by:<br>Jack Simpson Fire     | For:<br>Surf Restaurant<br>207 Main St.<br>Nashua, nh 03062 | LIC #:<br>Designer: LC<br>Job: UL300 Upgrade in rear kitchen<br>Date: 8/28/2020 |
|  | FlashPoint by FlashSoft, Inc. - www.flashsoft.com |   |   |

### Amerex Fire Suppression System Specifications

|   |  |
|---|--|
| <p style="text-align: center;"><b>120 VAC HORN &amp; STROBE</b></p> <p>P/N: 23394</p> | <p style="text-align: center;"><b>KP 275/375/475 DISCHARGE VALVE</b></p> <p>P/N: 32284</p> |
| <p style="text-align: center;"><b>CORNER PULLEY - AMEREX</b></p> <p>P/N: 32309</p>    | <p style="text-align: center;"><b>PULLEY TEE</b></p> <p>P/N: 32306</p>                     |

|  |   |   |   |
|--|---|---|---|
|  | Designed & Installed by:<br>Jack Simpson Fire     | For:<br>Surf Restaurant<br>207 Main St.<br>Nashua, nh 03062 | LIC #:<br>Designer: LC<br>Job: UL300 Upgrade in rear kitchen<br>Date: 8/28/2020 |
|  | FlashPoint by FlashSoft, Inc. - www.flashsoft.com |   |   |

### Amerex Fire Suppression System Specifications

|  |   |
|--|---|
| <p style="text-align: center;"><b>KP DISCHARGE NOZZLES</b></p> <p>P/N: 32284</p> | <p style="text-align: center;"><b>MANUAL PULL STATION</b></p> <p>P/N: 23481</p> |
|--|---|

|  |   |   |   |
|--|---|---|---|
|  | Designed & Installed by:<br>Jack Simpson Fire     | For:<br>Surf Restaurant<br>207 Main St.<br>Nashua, nh 03062 | LIC #:<br>Designer: LC<br>Job: UL300 Upgrade in rear kitchen<br>Date: 8/28/2020 |
|  | FlashPoint by FlashSoft, Inc. - www.flashsoft.com |   |   |

The Package Setup screen allows the drawing to be customized as needed (See Enhanced Drawing). Additionally, the Cover Page, Notes, and Specification Sheets can be selected and customized for the Submittal Package. This is especially convenient if the package is being printed to a PDF for electronic submission to the AHJ.

Orientation plays an important role in the creation of a submittal package. The Package orientation (Landscape or Portrait) that is selected on the Package Settingstab is used for all of the pages in the submittal package. However, the drawing pages have an orientation setting that can be used to override the package setting. For example, setting the package setting to Portrait would print all of the pages in the package in Portrait mode, but the drawings could be set to print in Landscape (or Portrait) using the buttons on the drawing tabs.

Amerex Pre-Engineered Fire Suppression System

DRAFT

FOR CONSTRUCTION

SCALE: 1/8" = 1'-0"

Total System Flow Points = 22, Flow Points Used = 18

|  |   |   |                                      |
|--|---|---|--------------------------------------|
|  | DESIGNED & INSTALLED BY:<br>JACK SIMPSON FIRE     | FOR:<br>SURF RESTAURANT<br>207 MAIN ST.<br>NASHUA, NH 03062 | LIC #:<br>DESIGNER:<br>JOB:<br>DATE: |
|  | FlashPoint by FlashSoft, Inc. - www.flashsoft.com |   |                                      |

## 8.3. Managing Credits



FlashPlanCredits are used to print drawings. All credits are stored in a database online, this is known as "The Bank".

A button at the bottom of the FlashPoints Tool Panel displays the number of credits in each customer's bank. Since the bank is located online, FlashPoints needs to be connected to the internet to see the bank. If FlashPoints is not connected to the internet, the button will display a question mark (?) to indicate that FlashPoints does not know how many credits are in the bank.

As credits are used, the new total in the bank will be reflected on this button. When it is time to refill the credit bank, the button may be clicked to go to the FlashPoints Store.

**NOTE:** FlashPlan credits are **ONLY** required for printing drawings. They are not required to print Notes, Cost Reports, or Submittal Pages.

## 8.4. Printing a Completion Certificate



**Installer:**

Fire & Safety  
123 Secret Road  
Anytown, MA 02703

Printed by:  
FlashPoints SuppressionCAD  
[www.flash-soft.com](http://www.flash-soft.com)

# Certificate of Fire System Compl

**Fire Suppression System:** Pyro-Chem Pre-Engineered Fire Suppression Sy  
**Fire System Type:** Wet Chemical - Kitchen System  
**Installation Location:** Mid City Grill  
106 S Main St  
Anytown, MA 02707  
**Drawing ID:** 100013-003-20211221-1000001

**This is to certify that the above fire suppression system has been ins  
per the referenced drawing.**

Installer's Signature:

Installation Date:



Providing a certificate of completion is a great way to inform AHJs and insurance companies that the fire suppression installed according to the approved plans. The customer's name and address, and the unique id of the drawing is printed on the certificate to identify the referenced plans.

## 9. Importing and Exporting

Occasionally, it may be necessary to copy the contents of the FlashPoints database for backup purposes or to copy the data to another computer. The Import and Export options on the FILE menu were created for this purpose.

To Export the FlashPoints database to a file, click on the Export item in the FILE menu. Then follow the instructions on the screen to save the contents of the database to a file. Files exported from FlashPoints will automatically have the extension .fpd added to the filename.

To Export the currently displayed FlashPoints job to a file, click on the Export the Current Job item in the FILE menu. Then follow the instructions on the screen to save the contents of the database to a file. Files exported from FlashPoints will automatically have the extension .fpd added to the filename.

To Import data from a file into the FlashPoints database, click on the Import item in the FILE menu. Follow the instructions on the screen to select the file to be imported. Only files with the .fpd extension can be imported into FlashPoints.

The Import feature should only be used to import a data file into an empty FlashPoints database. Since FlashPoints is unable to tell if the data being imported already exists in the database, it is possible to create duplicate items if jobs already exist in the database.

**NOTE:** Due to variations in database design from version to version of FlashPoints, an export file created in one version of FlashPoints may not import into a FlashPoints program with a different version number.

**WARNING:** The layout of the data in a .fpd file is very specific to FlashPoints. Any attempt to change or tamper with the data in a FlashPoints export file could result in the corruption of the FlashPoints database. Files exported from FlashPoints may only be imported into the same version of FlashPoints.



## 10. Setting Preferences

The Settings screen allows you to customize certain features of FlashPoints Suppression CAD. These changes are saved in the FlashPoints database and reapplied each time FlashPoints is run.

To open the Settings screen select EDIT | Settings from the Menu Bar.

The following items can be set in the Settings screen:

1. **Display Nozzle Labels:** FlashPoints can automatically display Nozzle Labels as nozzles are placed on the drawing canvas.
2. **Print Fire Equipment Dealer Phone Number:** The phone number of the fire equipment company will be printed below the name and address of the company.
3. **Print Scale Legend on Drawings:** A legend can be added to each drawing to indicate the scale of the drawing.
4. **Print System Flow Points:** The number of system flow points and actual flow points used are printed below the drawing.
5. **Print Manufacturer name on Drawings.** Text will be added to the upper right corner of printed drawings to indicate the manufacturer of the completed system.
6. **Discount rate:** [Fire Equipment Dealer Version Only] Enter the discount that you receive from your manufacturer. Typical values might be 25+5+5 or 20+10. FlashPoints will apply this discount to all manufacturer's items automatically.
7. **Pricing Currency:** Choose the local currency that you will be using to price jobs. The price of all appliances and protection items will be converted to this currency.
8. **Labor rate:** [Fire Equipment Dealer Version Only] This is your hourly labor charge. It will be used in the requirements screen when you enter the number of hours of labor for a job.
9. **Sales Tax:** [Fire Equipment Dealer Version Only] Enter the sales tax rate for your jurisdiction.
10. **Apply sales tax to labor:** [Fire Equipment Dealer Version Only] If you are required to collect sales tax for labor, in addition to goods, check this box.
11. **Apply Margin to Materials, Labor, Subcontractor:** Check the box or boxes that should be included in the Margin calculation on the Requirements screen.

After you have made changes to the Preference window, click the OK button to instantly apply the changes. If you do not want to save your changes, press the Cancel button to exit the Preferences window without saving.

## 10.1. Sharing a Database



When FlashPoints is installed on a computer, it creates a database to hold customer and job information. This is the default database that FlashPoints uses.

However, it is possible to create a database on another location, for example on a file server or a cloud drive (like Dropbox). Keeping the database on these locations makes it easier to backup FlashPoints data.

Additionally if the database is on a location that is shared with other computers, like a file server, and the other computers have FlashPoints installed on them, they can all share the jobs and customers in the database. This allows multiple people to collaborate on jobs or finish jobs that are started by someone else. Using a shared database also makes it easier to start a job in the office and finish it at home, or vice versa.

To use a shared database, click the **BROWSE** button next to the  icon on the **GENERAL** tab of the Settings window. Choose the location where the database is to be stored from the list that pops up. If the database does not exist, FlashPoints will create it and copy the jobs in the local database to the newly created remote database. If the database already exists, FlashPoints will switch to that database and

start using it (jobs will not be copied to an existing database).

To change back to the local database, check the box next to the . FlashPoints will forget the remote database and will use just the local database.

## 10.2. Adding a Company Logo

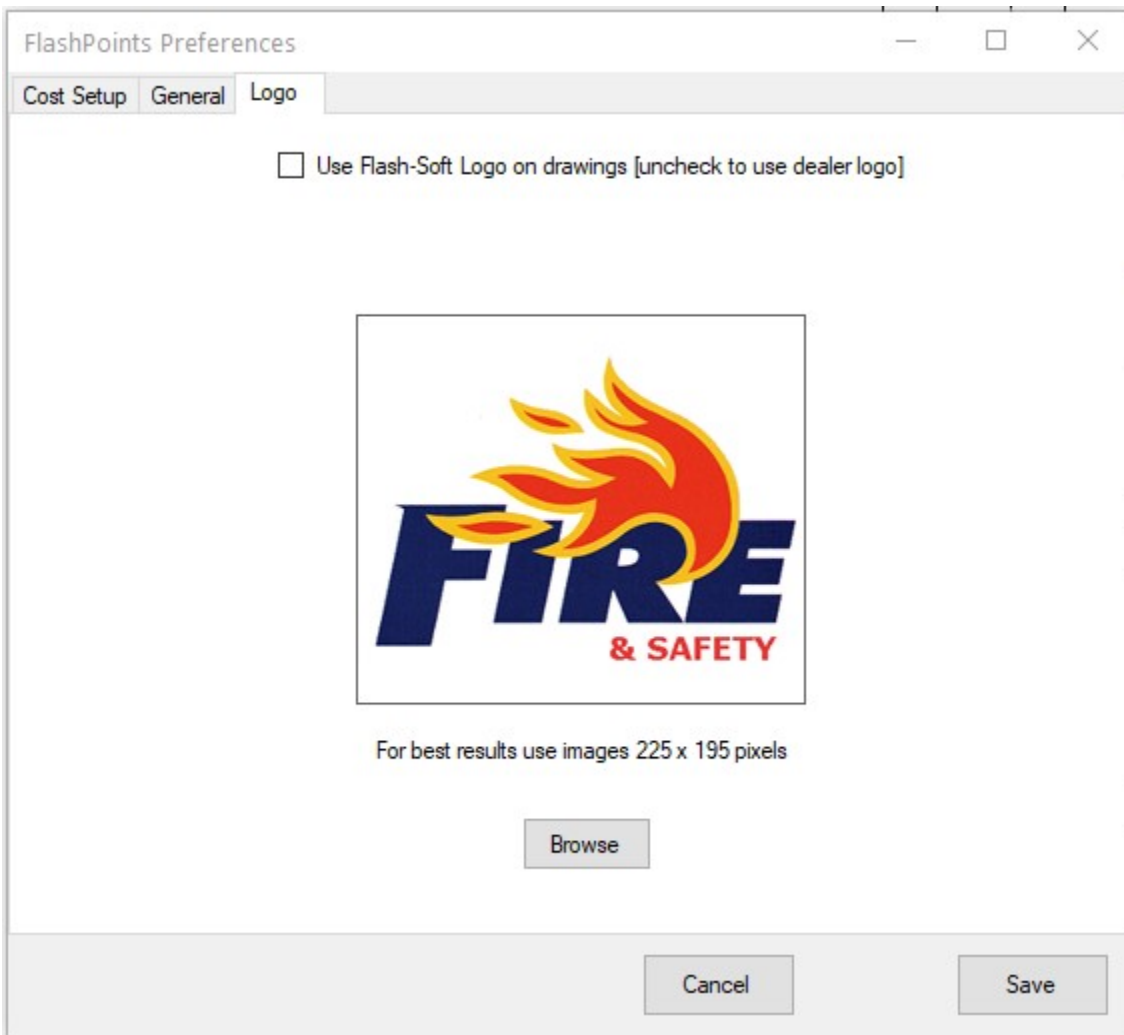

Use the LOGO tab in the Settings window to add a logo to FlashPoints. If no logo is added or if the checkbox at the top of the logo page is checked, FlashPoints will use the FlashPoints logo on all drawings and reports. Clicking the BROWSE button allows any image on the computer to be added to FlashPoints as the dealer's logo. The logo will only be saved to the FlashPoints database after the SAVE button is clicked.

# 11. FlashPoints Survey

## FlashPoints Survey

Arcane Corporation  
123 Secret Road  
Anytown  
MA  
02703



START A NEW JOB

OPEN EXISTING JOB

VIEW SUBMITTED JOBS

ACCOUNT SETTINGS

HELP

LOG OUT

**FlashPointsSurvey** is a web-based add-on to FlashPoints SuppressionCAD. What that means is that the application does not need to be installed. It will run in a web browser on a computer, phone, or tablet. In order to run the application, an account must be created to allow the user to login. Since this is an ADD-ON to FlashPoints, accounts must be purchased in the FlashPoints store before they can be created. The complete steps for creating an account are outlined in the "Setting Up a Survey User" topic.

Please note: it is necessary to purchase an account for each person that will be using FlashPointsSurvey.

## 11.1. Setting Up a Survey User



Setting up a new user account is a very simple process. If you have ever setup an online account, like on Amazon or Facebook, you are way ahead of the game.

Follow these steps to setup your FlashPoints Survey users:

1. Purchase the desired number of user accounts in the FlashPoints Store. You will need 1 account for each person who will be using FlashPoints Survey.
2. Open the Survey Setup window (shown at right) in FlashPoints. It is located under the Survey menu at the top of the FlashPoints screen.
3. Have each user scan the barcode with their smartphone or tablet. Alternatively, the web address below the barcode could be entered into a web browser on a laptop. However, a smartphone is the recommended device.

ON THE PHONE:

1. Click the CREATE A NEW USER button.





## 11.2. Importing a Survey

Importing a survey is as easy as opening a job in FlashPoints. In fact, they are both done from the FlashPoints Job Selector. Clicking the green button to import a survey will appear on the FlashPoints Job Selector. Click the green button to open the import window.

FlashPoints Job Selector

Select the Job to be opened and press the OPEN button.  
Press the NEW button to start a new job.

| ID | CAD | Company                               | Job Description             | Mfg       |
|----|-----|---------------------------------------|-----------------------------|-----------|
| 40 | R   | American Legion Post 287              | Strike Job                  | AX100-KP  |
| 12 | R   | American Legion Post 287              | UL 300 upgrade - 3          | R1000-RG  |
| 20 | R   | Angelas Pasta                         | bring system up to UL 300   | R1000-RG  |
| 6  | R   | Annulas Pizza & Deli                  | System Up Grade             | R1000-RG  |
| 55 | R   | Athens                                | Left Side                   | AN100-R10 |
| 19 | R   | Athens                                | New hood install            | AN100-R10 |
| 56 | R   | Athens                                | Right Side                  | AN100-R10 |
| 5  | R   | Birch Hill Terrace                    | UL 300 Upgrade              | R1000-RG  |
| 31 | R   | BUNNY'S SUPERETTE                     | New hood suppression system | R1000-RG  |
| 71 | R   | Bill's Tavern                         | Kitchen in Rear             | AN100-R10 |
| 72 | R   | Bill's Tavern                         | Kitchen in Rear             | AX100-KP  |
| 73 | R   | Bill's Tavern                         | Kitchen in Rear - 1         | PY100-KK  |
| 7  | R   | Brookside house of pizza              | UL300 UpGrade               | R1000-RG  |
| 11 | R   | Burger King at The Manchester Airport | Kitchen system              | R1000-RG  |
| 37 | R   | Chelby's Pizza & Subs                 | Kitchen                     | PY100-KK  |
| 2  | R   | Chelby's Pizza & Subs                 | UL300 Up Grade              | R1000-RG  |

NEW      FLASHPOINTS SURVEY JOBS      OPEN

Select the survey to be imported and choose the fire suppression system to be installed, then click the IMPORT button.

FlashPoints Survey Job Import

### 1. Select a job to import from FlashPoints Survey

| ID | CAD | Company          | Job Description | Name            | UOM |
|----|-----|------------------|-----------------|-----------------|-----|
| 1  | R   | Sam's Burger Bar | Kitchen         | Denis Perreault | US  |

### 2. Select a system for the job

## 11.3. Managing Survey Users

Survey User Maintenance
— □

### FlashPoints Survey Users

| ID | User ID | Name            | Status | Last Login          |
|----|---------|-----------------|--------|---------------------|
| 1  | Denis   | Denis Perreault | A      | 2022-05-24 13:07:24 |

Change St

Reset  
Passwo

Delete Us

Close

Status: A = Active; I = Inactive

The Survey User Maintenance screen allows you to manage your user account right in FlashPoints. Click on a user and choose one of the buttons on the right to apply the button's function to that user.

**Change Status** - toggle the user between Active and Inactive status. An active user can log into FlashPoints Survey. An inactive user cannot login. This will not affect surveys that have been submitted by the user.

**Reset Password** - passwords in FlashPoints Survey are encrypted. If a person forgets their password, this button will reset their password to their User ID. After the password has been reset they will be able to login and change the password in the FlashPoints Survey app.

**Delete User** - completely delete a user from FlashPoints Survey. This option will not only delete the user, but it will also delete all of the jobs they have in FlashPoints Survey. It is a good idea to process any submitted jobs before using this function. Deleting a user may be required if the user has left the company and you wish to assign the account to another person.



# Index

## A

Automatic Placement, 20

## D

Drawing, 18, 22, 27, 16, 15, 21, 17, 31

Duct, 17

## H

Hood, 16

## M

Minibar, 19, 38

## P

Pipe, 36, 37, 38, 39

Protection, 28

## T

The Canvas, 4, 8

The Menu, 4, 5

The Status Bar, 4, 9

The Tool Palette, 4, 7